

Spectrophotometer



PCSPECTRO II

SpectroDirect



Instruction Manual

Important steps before using the photometer

Please carry out the following steps as described in the Instruction manual. Become familiar with your new photometer before starting with the first tests:

- Unpacking and inspection of delivery contents, see page 352.

IMPORTANT NOTE:

Before using the SpectroDirect photometer it is necessary to insert the two batteries. The batteries save data if there is no power from the mains adapter, see page 296.

- Connect the Photometer to the mains adapter power supply.
- Before each switch on, make sure that the **sample chamber is empty** and the **photometer lid is closed**, as the photometer always performs a self-test when it is switched on.

Perform the following settings in the Mode-Menu; Instruction manual from page 307 and following:

- MODE 10: select language
- MODE 12: set date and time
- **MODE 34: perform "Delete data"**
- **MODE 69: perform "User m. init" to initialise the user polynomial system**

If required set other functions.



DE

Wichtige Information

Um die Qualität unserer Umwelt zu erhalten, beschützen und zu verbessern Entsorgung von elektronischen Geräten in der Europäischen Union

Aufgrund der Europäischen Verordnung 2012/19/EU darf Ihr elektronisches Gerät nicht mit dem normalen Hausmüll entsorgt werden!

Tintometer GmbH entsorgt ihr elektrisches Gerät auf eine professionelle und für die Umwelt verantwortungsvolle Weise. Dieser Service ist, **die Transportkosten nicht inbegriffen**, kostenlos. Dieser Service gilt ausschließlich für elektrische Geräte die nach dem 13.08.2005 erworben wurden. Senden Sie Ihre zu entsorgenden Tintometer Geräte frei Haus an Ihren Lieferanten.

GB

Important Information

To Preserve, Protect and Improve the Quality of the Environment Disposal of Electrical Equipment in the European Union

Because of the European Directive 2012/19/EU your electrical instrument must not be disposed of with normal household waste!

Tintometer GmbH will dispose of your electrical instrument in a professional and environmentally responsible manner. This service, **excluding the cost of transportation** is free of charge. This service only applies to electrical instruments purchased after 13th August 2005. Send your electrical Tintometer instruments for disposal freight prepaid to your supplier.

FR

Notice importante

Conserver, protéger et optimiser la qualité de l'environnement Élimination du matériel électrique dans l'Union Européenne

Conformément à la directive européenne n° 2012/19/UE, vous ne devez plus jeter vos instruments électriques dans les ordures ménagères ordinaires !

La société Tintometer GmbH se charge d'éliminer vos instruments électriques de façon professionnelle et dans le respect de l'environnement. Ce service, **qui ne comprend pas les frais de transport**, est gratuit. Ce service n'est valable que pour des instruments électriques achetés après le 13 août 2005. Nous vous prions d'envoyer vos instruments électriques Tintometer usés à vos frais à votre fournisseur.

NL

Belangrijke informatie

Om de kwaliteit van ons leefmilieu te behouden, te verbeteren en te beschermen is voor landen binnen de Europese Unie de Europese richtlijn 2012/19/EU voor het verwijderen van elektronische apparatuur opgesteld.

Volgens deze richtlijn mag elektronische apparatuur niet met het huishoudelijk afval worden afgevoerd.

Tintometer GmbH verwijdert uw elektronisch apparaat op een professionele en milieubewuste wijze. Deze service is, **exclusief de verzendkosten**, gratis en alleen geldig voor elektrische apparatuur die na 13 augustus 2005 is gekocht. Stuur uw te verwijderen Tintometer apparatuur franco aan uw leverancier.



ES

Información Importante

Para preservar, proteger y mejorar la calidad del medio ambiente Eliminación de equipos eléctricos en la Unión Europea

Con motivo de la Directiva Europea 2012/19/UE, ¡ningún instrumento eléctrico deberá eliminarse junto con los residuos domésticos diarios!

Tintometer GmbH se encargará de dichos instrumentos eléctricos de una manera profesional y sin dañar el medio ambiente. Este servicio, **el cual excluye los gastos de transporte**, es gratis y se aplicará únicamente a aquellos instrumentos eléctricos adquiridos después del 13 de agosto de 2005. Se ruega enviar aquellos instrumentos eléctricos inservibles de Tintometer a carga pagada a su distribuidor.

IT

Informazioni importanti

Conservare, proteggere e migliorare la qualità dell'ambiente Smaltimento di apparecchiature elettriche nell'Unione Europea

In base alla Direttiva europea 2012/19/UE, gli apparecchi elettrici non devono essere smaltiti insieme ai normali rifiuti domestici!

Tintometer GmbH provvederà a smaltire i vostri apparecchi elettrici in maniera professionale e responsabile verso l'ambiente. Questo servizio, **escluso il trasporto**, è completamente gratuito. Il servizio si applica agli apparecchi elettrici acquistati successivamente al 13 agosto 2005. Siete pregati di inviare gli apparecchi elettrici Tintometer divenuti inutilizzabili a trasporto pagato al vostro rivenditore.

PT

Informação Importante

Para Preservar, Proteger e Melhorar a Qualidade do Ambiente Remoção de Equipamento Eléctrico na União Europeia

Devido à Directiva Europeia 2012/19/UE, o seu equipamento eléctrico não deve ser removido com o lixo doméstico habitual!

A Tintometer GmbH tratará da remoção do seu equipamento eléctrico de forma profissional e responsável em termos ambientais. Este serviço, **não incluindo os custos de transporte**, é gratuito. Este serviço só é aplicável no caso de equipamentos eléctricos comprados depois de 13 de Agosto de 2005. Por favor, envie os seus equipamentos eléctricos Tintometer que devem ser removidos ao seu fornecedor (transporte pago).

PL

Istotna informacja

Dla zachowania, ochrony oraz poprawy naszego środowiska Usuwanie urządzeń elektronicznych w Unii Europejskiej

Na podstawie Dyrektywy Parlamentu Europejskiego 2012/19/UE nie jest dozwolone usuwanie zakupionych przez Państwo urządzeń elektronicznych wraz z normalnymi odpadami z gospodarstwa domowego!

Tintometer GmbH usunie urządzenia elektrycznego Państwa w sposób profesjonalny i odpowiedzialny z punktu widzenia środowiska. Serwis ten jest, za wyjątkiem kosztów transportu, bezpłatny. Serwis ten odnosi się wyłącznie do urządzeń elektrycznych zakupionych po 13.08.2005r. Przeznaczony do usunięcia urządzenia firmy Tintometer mogą Państwo przesyłać na koszt własny do swojego dostawcy.

DE

Wichtiger Entsorgungshinweis zu Batterien und Akkus

Jeder Verbraucher ist aufgrund der Batterieverordnung (Richtlinie 2006/66/EG) gesetzlich zur Rückgabe aller ge- und verbrauchten Batterien bzw. Akkus verpflichtet. Die Entsorgung über den Hausmüll ist verboten. Da auch bei Produkten aus unserem Sortiment Batterien und Akkus im Lieferumfang enthalten sind, weisen wir Sie auf folgendes hin:

Verbrauchte Batterien und Akkus gehören nicht in den Hausmüll, sondern können unentgeltlich bei den öffentlichen Sammelstellen Ihrer Gemeinde und überall dort abgegeben werden, wo Batterien und Akkus der betreffenden Art verkauft werden. Weiterhin besteht für den Endverbraucher die Möglichkeit, Batterien und Akkus an den Händler, bei dem sie erworben wurden, zurückzugeben (gesetzliche Rücknahmepflicht).

GB

Important disposal instructions for batteries and accumulators

EC Guideline 2006/66/EC requires users to return all used and worn-out batteries and accumulators. They must not be disposed of in normal domestic waste. Because our products include batteries and accumulators in the delivery package our advice is as follows :

Used batteries and accumulators are not items of domestic waste. They must be disposed of in a proper manner. Your local authority may have a disposal facility; alternatively you can hand them in at any shop selling batteries and accumulators. You can also return them to the company which supplied them to you; the company is obliged to accept them.

FR

Information importante pour l'élimination des piles et des accumulateurs

En vertu de la Directive européenne 2006/66/CE relative aux piles et accumulateurs, chaque utilisateur est tenu de restituer toutes les piles et tous les accumulateurs utilisés et épuisés. L'élimination avec les déchets ménagers est interdite. Etant donné que l'étendue de livraison des produits de notre gamme contient également des piles et des accumulateurs, nous vous signalons ce qui suit :

les piles et les accumulateurs utilisés ne sont pas des ordures ménagères, ils peuvent être remis sans frais aux points de collecte publics de votre municipalité et partout où sont vendus des piles et accumulateurs du type concerné. Par ailleurs, l'utilisateur final a la possibilité de remettre les piles et les accumulateurs au commerçant auprès duquel ils ont été achetés (obligation de reprise légale).

NL

Belangrijke mededeling omtrent afvoer van batterijen en accu's

Ledere verbruiker is op basis van de richtlijn 2006/66/EG verplicht om alle gebruikte batterijen en accu's in te leveren. Het is verboden deze af te voeren via het huisvuil. Aangezien ook onze producten geleverd worden met batterijen en accu's wijzen wij u op het volgende; Lege batterijen en accu's horen niet in het huisvuil thuis. Men kan deze inleveren bij inzamelpunten van uw gemeente of overal daar waar deze verkocht worden. Tevens bestaat de mogelijkheid batterijen en accu's daar in te leveren waar u ze gekocht heeft. (wettelijke terugnameplicht)



ES**Indicación importante acerca de la eliminación de pilas y acumuladores**

Basado en la norma relativa a pilas/ baterías (directiva 2006/66/CE), cada consumidor, está obligado por ley, a la devolución de todas las pilas/ baterías y acumuladores usados y consumidos. Está prohibida la eliminación en la basura doméstica. Ya que en productos de nuestra gama, también se incluyen en el suministro pilas y acumuladores, le sugerimos lo siguiente:

Las pilas y acumuladores usados no pertenecen a la basura doméstica, sino que pueden ser entregados en forma gratuita en cada uno de los puntos de recolección públicos de su comunidad en los cuales se vendan pilas y acumuladores del tipo respectivo. Además, para el consumidor final existe la posibilidad de devolver las pilas y baterías recargables a los distribuidores donde se hayan adquirido (obligación legal de devolución).

IT**Indicazioni importanti sullo smaltimento di pile e accumulatori**

In base alla normativa concernente le batterie (Direttiva 2006/66/CE) ogni consumatore è tenuto per legge alla restituzione di tutte le batterie o accumulatori usati ed esauriti. È vietato lo smaltimento con i rifiuti domestici. Dato che anche alcuni prodotti del nostro assortimento sono provvisti di pile e accumulatori, vi diamo di seguito delle indicazioni: Pile e accumulatori esauriti non vanno smaltiti insieme ai rifiuti domestici, ma depositati gratuitamente nei punti di raccolta del proprio comune o nei punti vendita di pile e accumulatori dello stesso tipo. Inoltre il consumatore finale può portare batterie e accumulatori al rivenditore presso il quale li ha acquistati (obbligo di raccolta previsto per legge).

PT**Instruções importantes para a eliminação residual de pilhas e acumuladores**

Os utilizadores finais são legalmente responsáveis, nos termos do Regulamento relativo a pilhas e acumuladores (Directiva 2006/66/CE), pela entrega de todas as pilhas e acumuladores usados e gastos. É proibida a sua eliminação juntamente com o lixo doméstico. Uma vez que determinados produtos da nossa gama contêm pilhas e/ou acumuladores, alertamos para os seguintes aspectos:

As pilhas e acumuladores usados não podem ser eliminados com o lixo doméstico, devendo sim ser entregues, sem encargos, junto dos pontos de recolha públicos do seu município, ou em qualquer ponto de venda de pilhas e acumuladores. O utilizador final dispõe ainda da possibilidade de entregar as pilhas e/ou acumuladores no estabelecimento comerciante onde os adquiriu (dever legal de aceitar a devolução).

PL**Istotna wskazówka dotycząca utylizacji baterii i akumulatorów**

Każdy użytkownik na mocy rozporządzenia w sprawie baterii (wytyczna 2006/66/WE) jest ustawowo zobowiązany do oddawania wszystkich rozładowanych i zużytych baterii lub akumulatorów. Utylizacja wraz z odpadkami domowymi jest zabroniona. Ponieważ także w produktach z naszego asortymentu zawarte są w zakresie dostawy baterie i akumulatory, zwracamy uwagę na poniższe zasady: zużyte baterie i akumulatory nie mogą być wyrzucane wraz z odpadkami domowymi, lecz powinny być bezpłatnie przekazywane w publicznych miejscach zbiórki wyznaczonych przez gminę lub oddawane w punktach, gdzie sprzedawane są baterie i akumulatory danego rodzaju. Poza tym użytkownik końcowy ma możliwość zwrócenia baterii i akumulatorów do przedstawiciela handlowego, u którego je nabył (ustawowy obowiązek przyjęcia).



Safety precautions



Reagents are formulated exclusively for chemical analysis and must not be used for any other purpose. Reagents must not get into the hands of children. Some of the reagents contain substances which are not entirely harmless environmentally. Be aware of the ingredients and take proper care when disposing of the test solution.



Please read this instruction manual before unpacking, setting up or using the photometer. Please read the method description completely before performing the test. Be aware of the risks of using the required reagents by reading the MSDS (Material Safety Data Sheets). Failure could result in serious injury to the operator or damage to the instrument.

MSDS:

www.lovibond.com

SpectroDirect/PC Spectro II_8c 02/2021

Table of contents

Part 1 Methods	9
1.1 Table of Methods.....	10
Acid demand to pH 4.3.....	16
Alkalinity-p (p-Value).....	18
Alkalinity-total (Alkalinity-m, m-Value).....	20
Alkalinity-total HR (Alkalinity-m HR, m-Value HR).....	22
Aluminium with tablets.....	24
Aluminium (Powder Pack).....	26
Ammonia with tablet.....	28
Ammonia (Powder Pack).....	30
Ammonia, low range (LR).....	32
Ammonia, high range (HR).....	34
Arsenic.....	36
Boron.....	40
Bromine.....	42
Bromine.....	44
Bromine.....	46
Cadmium.....	48
Chloride with tablet.....	50
Chloride.....	52
Chlorine.....	54
Chlorine with tablet.....	56
differentiated determination (free, combined, total).....	56
free Chlorine.....	57
total Chlorine.....	58
Chlorine with tablet.....	59
differentiated determination (free, combined, total).....	59
free Chlorine.....	60
total Chlorine.....	61
Chlorine with tablet.....	62
free Chlorine.....	62
total Chlorine.....	63
differentiated determination (free, combined, total).....	64
Chlorine HR with tablet.....	66
free Chlorine.....	66
total Chlorine.....	67
differentiated determination (free, combined, total).....	68

Chlorine with liquid reagent.....	70
free Chlorine.....	70
total Chlorine.....	71
differentiated determination (free, combined, total)	72
Chlorine (Powder Pack).....	74
free Chlorine.....	74
total Chlorine.....	75
differentiated determination (free, combined, total)	76
Chlorine MR (VARIO Powder Pack).....	78
free Chlorine.....	78
total Chlorine.....	79
differentiated determination (free, combined, total)	80
Chlorine HR (KI).....	82
Chlorine dioxide, in absence of Chlorine	84
Chlorine dioxide.....	86
in presence of Chlorine	88
in absence of Chlorine	91
Chromium (Powder Pack).....	92
differentiated determination	94
Chromium (VI)	96
Chromium, total (Cr(III) + Cr(VI)).....	97
differentiated determination	98
Chromium (VI)	100
Chromium, total (Cr(III) + Cr(VI)).....	101
COD, low range (LR)	102
COD, middle range (MR).....	104
COD, high range (HR)	106
Colour, true and apparent.....	108
Copper with tablet.....	110
differentiated determination (free, combined, total)	112
free Copper	114
total Copper	115
differentiated determination (free, combined, total)	116
free Copper	118
total Copper	119
Copper, free (Powder Pack).....	120
Cyanide	122
Cyanide	124
CyA-TEST (Cyanuric acid)	126
DEHA T.....	128

DEHA (Powder Pack).....	130
Fluoride	132
Formaldehyde, 10 mm.....	134
Formaldehyde, 50 mm.....	136
Formaldehyde, 16 mm.....	138
Hardness, total.....	140
Hardness, total HR.....	142
Hydrazine	144
Hydrazine with liquid reagent	146
Hydrogen peroxide	148
Hydrogen peroxide	150
Iodine	152
Iron.....	154
Iron with tablet	156
Iron with tablet	158
Iron with tablet	160
Iron (Powder Pack)	162
Iron TPTZ (Powder Pack)	164
Lead, 10 mm	166
Lead, 16 mm	168
Procedure A	169
Procedure B	170
Manganese with tablet	172
Manganese LR (Powder Pack).....	174
Manganese HR (Powder Pack).....	176
Molybdate with tablet.....	178
Molybdate LR (Powder Pack).....	180
Molybdate HR (Powder Pack)	182
Nickel	184
Nickel	186
Nitrate	188
Nitrate LR.....	190
Nitrite with tablet.....	192
Nitrite LR (Powder Pack).....	194
Nitrite LR.....	196
Nitrite HR.....	198
Nitrogen, total LR.....	200
Nitrogen, total HR.....	202
Nitrogen, total LR 2.....	206
Nitrogen, total HR 2.....	208

Oxygen, active	210
Ozone.....	212
in presence of Chlorine	214
in absence of Chlorine	216
in presence of Chlorine	218
in absence of Chlorine	220
pH value with tablet.....	222
pH value with liquid reagent	224
Phenol	226
Phosphate.....	228
Phosphate, total (tube test)	230
Phosphate, total LR (tube test).....	232
Phosphate, total HR (tube test).....	234
Phosphate, ortho LR with tablet	236
Phosphate, ortho HR with tablet	238
Phosphate, ortho (Powder Pack).....	240
Phosphate, ortho (Vario tube test).....	242
Phosphate, ortho (tube test).....	244
Phosphate, hydrolyzable (tube test)	246
Phosphonates	248
Potassium	252
S Abs, Spectral Absorption Coefficient.....	254
Silica	256
Silica LR PP.....	258
Silica HR PP.....	260
Sulfate (Powder Pack)	262
Sulfide	264
Sulfite	266
Sulfite.....	268
Surfactants, anionic (No. 1.14697.0001).....	270
Surfactants, anionic (No. 1.02552.0001).....	272
Surfactants, nonionic (No. 1.01787.0001).....	274
Surfactants, cationic (No. 1.01764.0001)	276
Suspended Solids.....	278
TOC LR	280
TOC HR	282
Turbidity	284
Urea	286
Zinc	288

1.2	Important notes	290
1.2.1	Correct use of reagents	290
1.2.2	Cleaning of vials and accessories for analysis	291
1.2.3	Guidelines for photometric measurements	292
1.2.4	Sample dilution techniques.....	293
1.2.5	Correcting for volume additions	293

Part 2 Instrument Manual 295

2.1	Operation.....	296
2.1.1	Commissioning	296
2.1.2	Batteries (only SpectroDirect).....	296
2.1.3	Lithium-battery (only PC Spectro II).....	296
2.1.4	Cell chamber and cells.....	297
2.2	Overview of function keys	298
2.2.1	Overview.....	298
2.2.2	Displaying time and date	298
2.2.3	User countdown.....	299
2.3	Operation mode.....	300
2.3.1	Selftest.....	300
2.3.2	Selecting a method	301
2.3.2.1	Method Information (F1)	301
2.3.2.2	Chemical Species Information.....	301
2.3.3	Differentiation.....	302
2.3.4	Performing Zero	302
2.3.5	Performing Tests.....	303
2.3.6	Ensuring reaction periods (countdown).....	303
2.3.7	Changing chemical species.....	304
2.3.8	Storing results	304
2.3.9	Printing results	305
2.3.10	Perform additional measurements	306
2.3.11	Selecting a new method.....	306
2.4	Photometer settings: Table of Mode Functions.....	307
2.4.1	blank because of technical requirements	308
2.4.2	Instrument basic settings 1	308
2.4.3	Printing of stored results.....	312
2.4.4	Recall / delete stored results.....	317
2.4.5	Calibration	321
2.4.6	Lab function.....	326
	Profi-Mode.....	326

	Absorption / Transmission.....	327
	Spectrum (Scan).....	328
	Kinetic.....	330
2.4.7	User operations.....	334
	User method list.....	334
	User Concentration Methods.....	336
	User Polynomials.....	338
	Delete User Methods.....	341
	Print Data of User Methods.....	342
	Initialise User Method System.....	343
2.4.8	Special functions.....	344
	Langelier Saturation Index.....	344
2.4.9	Instrument basic settings 2.....	346
2.4.10	Instrument special functions /service.....	347
2.5	Data transfer.....	348
2.5.1	Connection to a printer.....	349
2.5.2	Data transfer to a personal computer.....	349
2.5.3	Internet Updates.....	350
Part 3 Enclosure.....		351
3.1	Unpacking.....	352
3.2	Delivery contents.....	352
3.3	blank because of technical requirements.....	352
3.4	Technical data.....	353
3.5	Abbreviations.....	354
3.6	Troubleshooting.....	355
3.6.1	Operating messages in the display / error display.....	355
3.6.2	General.....	357
3.6.3	Service / Maintains.....	358
3.6.3.1	Handling & Cleaning.....	358
3.6.3.2	Changing the light-source.....	358
3.6.3.3	Changing the lithium battery (only PC Spectro II).....	359
3.6.3.4	Changing the batteries (only SpectroDirect).....	360
3.7	Declaration of CE-Conformity.....	361

Part 1

Methods

1.1 Table of Methods

No.	Analysis	Reagent	Range	Displayed as	Method	λ [nm]	Page
20	Acid demand to pH 4.3 T	tablet	0.1-4	mmol/l	Acid/Indicator ^{1,2,5}	615	16
35	Alkalinity-p T	tablet	5-300	mg/l CaCO ₃	Acid/Indicator ^{1,2,5}	551	18
30	Alkalinity, total T	tablet	5-200	mg/l CaCO ₃	Acid/Indicator ^{1,2,5}	615	20
31	Alkalinity HR, total T	tablet	5-500	mg/l CaCO ₃	Acid/Indicator ^{1,2,5}	615	22
40	Aluminium T	tablet	0.01-0.3	mg/l Al	Eriochrome Cyanine R ²	535	24
50	Aluminium PP	powder pack	0.01-0.25	mg/l Al	Eriochrome Cyanine R ²	535	26
60	Ammonia T	tablet	0.02-1	mg/l N	Indophenol blue ^{2,3}	676	28
62	Ammonia PP	powder pack	0.01-0.8	mg/l N	Salicylate ²	655	30
65	Ammonia LR TT	tube test	0.02-2.5	mg/l N	Salicylate ²	655	32
66	Ammonia HR TT	tube test	1-50	mg/l N	Salicylate ²	655	34
68	Arsenic	see test instructions	0.02-0.6	mg/l As	Silverdiethyldithiocarbamate ¹	507	36
85	Boron T	tablet	0.1-2	mg/l B	Azomethine ³	450	40
78	Bromine 10 T	tablet	0.1-3	mg/l Br ₂	DPD ⁵	510	42
79	Bromine 50 T	tablet	0.05-1	mg/l Br ₂	DPD ⁵	510	44
80	Bromine T	tablet	0.05-6.5	mg/l Br ₂	DPD ⁵	510	46
87	Cadmium TT	tube test	0.025-0.75	mg/l Cd	Cadion ⁶	525	48
90	Chloride T	tablet	0.5-25	mg/l Cl ⁻	Silver nitrate/turbidity	450	50
91	Chloride L	liquid	5-60	mg/l Cl ⁻	Iron(III)-thiocyanate ⁴	455	52
98	Chlorine 10 T *	tablet	0.1-6	mg/l Cl ₂	DPD ^{1,2,3}	510	54, 56
99	Chlorine 50 T *	tablet	0.02-0.5	mg/l Cl ₂	DPD ^{1,2,3}	510	54, 59
100	Chlorine T *	tablet	0.02-3	mg/l Cl ₂	DPD ^{1,2,3}	510	54, 62
104	Chlorine HR 10 T *	tablet	0.1-10	mg/l Cl ₂	DPD ^{1,2,3}	510	54, 66
101	Chlorine L *	liquid	0.02-3	mg/l Cl ₂	DPD ^{1,2,3}	510	54, 70
110	Chlorine PP *	powder pack	0.01-2	mg/l Cl ₂	DPD ^{1,2}	510	54, 74
113	Chlorine MR PP *	powder pack	0.01-3.5	mg/l Cl ₂	DPD ^{1,2}	510	54, 78

No.	Analysis	Reagent	Range	Displayed as	Method	λ [nm]	Page
105	Chlorine HR (KI) T	tablet	5-200	mg/l Cl ₂	KI/Acid ⁵	470	82
119	Chlorine dioxide 50 T	tablet	0.05-1	mg/l ClO ₂	DPD, Glycine ^{1,2}	510	84
120	Chlorine dioxide T	tablet	0.05-2.5	mg/l ClO ₂	DPD, Glycine ^{1,2}	510	86
124	Chromium 50 PP	powder pack	0.005-0.5	mg/l Cr	1,5-Diphenyl-carbohydrazide ^{1,2}	542	92, 94
125	Chromium PP	powder pack	0.02-2	mg/l Cr	1,5-Diphenyl-carbohydrazide ^{1,2}	542	92, 98
130	COD LR TT	tube test	3-150	mg/l O ₂	Dichromate/H ₂ SO ₄ ^{1,2}	420	102
131	COD MR TT	tube test	20-1500	mg/l O ₂	Dichromate/H ₂ SO ₄ ^{1,2}	620	104
132	COD HR TT	tube test	0.2-15	g/l O ₂	Dichromate/H ₂ SO ₄ ^{1,2}	620	106
203	Colour 50	direct reading	0-500	Pt-Co units	Pt-Co-Scale ^{1,2} (APHA)	455	108
149	Copper 50 T	tablet	0.05-1	mg/l Cu	Biquinoline ⁴	559	110, 112
150	Copper T *	tablet	0.5-5	mg/l Cu	Biquinoline ⁴	559	110, 116
153	Copper PP	powder pack	0.05-5	mg/l Cu	Bicinchoninate	560	110, 120
156	Cyanide 50 L	powder + liquid	0.005-0.2	mg/l CN	Pyridine barbituric acid ¹	585	122
157	Cyanide L	powder + liquid	0.01-0.5	mg/l CN	Pyridine barbituric acid ¹	585	124
160	CyA-TEST T	tablet	0-160	mg/l CyA	Melamine	530	126
165	DEHA T	tablet + liquid	20-500	μ g/l DEHA	PPST ³	562	128
167	DEHA PP	powder + liquid	20-500	μ g/l DEHA	PPST ³	562	130
170	Fluoride L	liquid	0.05-1.5	mg/l F	SPADNS ²	580	132
175	Formaldehyde 10	powder + liquid	1-5	mg/l HCHO	H ₂ O ₂ /Chromotropic acid ⁶	585	134
176	Formaldehyde 50	powder + liquid	0.02-1	mg/l HCHO	H ₂ O ₂ /Chromotropic acid ⁶	585	136
177	Formaldehyde TT	tube test	0.1-5	mg/l HCHO	H ₂ O ₂ /Chromotropic acid ⁶	575	138
200	Hardness, total T	tablet	2-50	mg/l CaCO ₃	Metallphthalein ³	571	140
201	Hardness, total HR T	tablet	20-500	mg/l CaCO ₃	Metallphthalein ³	571	142
205	Hydrazine P	powder	0.05-0.5	mg/l N ₂ H ₄	4-(Dimethylamino)-benzaldehyde ³	455	144

No.	Analysis	Reagent	Range	Displayed as	Method	λ [nm]	Page
206	Hydrazine L	liquid	0.005-0.6	mg/l N ₂ H ₄	4-(Dimethylamino)-benzaldehyde ³	455	146
209	Hydrogen peroxide 50 T	tablet	0.01-0.5	mg/l H ₂ O ₂	DPD/Catalyst ⁵	510	148
210	Hydrogen peroxide T	tablet	0.03-1.5	mg/l H ₂ O ₂	DPD/Catalyst ⁵	510	150
215	Iodine T	tablet	0.05-3.6	mg/l I	DPD ⁵	510	152
218	Iron 10 T	tablet	0.1-1	mg/l Fe	PPST ³	562	154, 156
219	Iron 50 T	tablet	0.01-0.5	mg/l Fe	PPST ³	562	154, 158
220	Iron LR T	tablet	0.01-1	mg/l Fe	PPST ³	562	154, 160
222	Iron PP	powder pack	0.1-3	mg/l Fe	1,10-Phenantroline ³	510	154, 162
223	Iron (TPTZ) PP	powder pack	0.1-1.8	mg/l Fe	TPTZ	590	154, 164
232	Lead 10	liquid	0.1-5	mg/l Pb	4-(2-Pyridylazo)-resorcin ⁶	520	166
234	Lead (A) TT	tube test	0.1-5	mg/l Pb	4-(2-Pyridylazo)-resorcin ⁶	515	168, 169
235	Lead (B) TT	tube test	0.1-5	mg/l Pb	4-(2-Pyridylazo)-resorcin ⁶	515	168, 170
240	Manganese T	tablet	0.2-4	mg/l Mn	Formaloxime	450	172
242	Manganese LR PP	powder pack + liquid	0.01-0.7	mg/l Mn	PAN	558	174
243	Manganese HR PP	powder pack	0.1-18	mg/l Mn	Periodate oxidation ²	525	176
250	Molybdate T	tablet	1-30	mg/l MoO ₄	Thioglycolate ⁴	366	178
251	Molybdate LR PP	powder pack	0.05-5	mg/l MoO ₄	Ternary Complex	610	180
252	Molybdate HR PP	powder pack	0.5-66	mg/l MoO ₄	Mercaptoacetic acid	420	182
255	Nickel 50 L	powder + liquid	0.02-1	mg/l Ni	Dimethyl-glyoxime ^{2,3}	443	184
256	Nickel L	powder + liquid	0.2-7	mg/l Ni	Dimethyl-glyoxime ^{2,3}	443	186
265	Nitrate TT	tube test	1-30	mg/l N	Chromotropic acid	410	188
267	Nitrate LR TT	tube test	0.5-14	mg/l N	2,6-Dimethyl-phenol ^{2,3}	340	190

No.	Analysis	Reagent	Range	Displayed as	Method	λ [nm]	Page
270	Nitrite T	tablet	0.01-0.5	mg/l N	N-(1-Naphthyl)-ethylendiamine ^{2,3}	545	192
272	Nitrite PP	powder pack	0.01-0.3	mg/l N	Diazotization	507	194
275	Nitrite LR TT	tube test	0.03-0.6	mg/l N	Sulfanilic acid/ Naphthylamine ¹	545	196
276	Nitrite HR TT	tube test	0.3-3	mg/l N	Sulfanilic acid/ Naphthylamine ¹	545	198
280	Nitrogen, total LR TT	tube test	0.5-25	mg/l N	Persulfate digestion method	410	200
281	Nitrogen, total HR TT	tube test	5-150	mg/l N	Persulfate digestion method	410	202
283	Nitrogen, total LR 2 TT	tube test	0.5-14	mg/l N	2,6 Dimethyl-phenol ^{2,3}	340	206
284	Nitrogen, total HR 2 TT	tube test	5-140	mg/l N	2,6 Dimethyl-phenol ^{2,3}	340	208
290	Oxygen, active T	tablet	0.1-10	mg/l O ₂	DPD	510	210
299	Ozone (DPD) 50	tablet	0.02-0.5	mg/l O ₃	DPD/Glycine ⁵	510	212, 214
300	Ozone (DPD) T	tablet	0.02-1	mg/l O ₃	DPD/Glycine ⁵	510	212, 218
330	pH-Value T	tablet	6.5-8.4	—	Phenol red ⁵	558	222
331	pH-Value L	liquid	6.5-8.4	—	Phenol red ⁵	558	224
315	Phenol T	tablet	0.1-5	mg/l C ₆ H ₅ OH	4-Aminoantipyrine ¹	507	226
326	Phosphate, total TT	tube test	0.02-1.1	mg/l P	Acid persulf. digestion, Ascorbic acid ²	890	228, 230
317	Phosphate, total LR TT	tube test	0.07-3	mg/l P	Phosphomolybdic acid / Ascorbic acid ²	690	228, 232
318	Phosphate, total HR TT	tube test	1.5-20	mg/l P	Phosphomolybdic acid / Ascorbic acid ²	690	228, 234
320	Phosphate, ortho LR T	tablet	0.05-4	mg/l PO ₄	Ammonium-molybdate ^{2,3}	710	228, 236
321	Phosphate, ortho HR T	tablet	1-80	mg/l PO ₄	Vanado-molybdate ²	470	228, 238
323	Phosphate, ortho PP	powder pack	0.06-2.5	mg/l PO ₄	Molybdate/ Ascorbic acid ²	890	228, 240
324	Phosphate, ortho TT	tube test	0.06-5	mg/l PO ₄	Molybdate/ Ascorbic acid ²	890	228, 242
322	Phosphate, ortho (VM) TT	tube test	3-60	mg/l PO ₄	Vanadomolybdate ²	438	228, 244
325	Phosphate, hydr. TT	tube test	0.02-1.6	mg/l P	Acid digestion/ Ascorbic acid ²	890	228, 246

No.	Analysis	Reagent	Range	Displayed as	Method	λ [nm]	Page
316	Phosphonate PP	powder pack	0-125	mg/l P	Persulfate UV-Oxidation	890	248
340	Potassium T	tablet	1-16	mg/l K	Tetraphenylborate-Turbidity ⁴	730	252
345	S Abs 436 nm (Colour)	direct reading	0-50	m-1	EN ISO 7887:1994 ¹	436	254
346	S Abs 525 nm (Colour)	direct reading	0-50	m-1	EN ISO 7887:1994 ¹	525	254
347	S Abs 620 nm (Colour)	direct reading	0-50	m-1	EN ISO 7887:1994 ¹	620	254
350	Silica T	tablet	0.05-3	mg/l SiO ₂	Silicomolybdate ^{2,3}	820	256
351	Silica LR PP	powder pack	0.1-1.6	mg/l SiO ₂	Heteropolyblue ²	815	258
352	Silica HR PP	powder pack	1-100	mg/l SiO ₂	Silicomolybdate	452	260
360	Sulfate PP	powder pack	2-100	mg/l SO ₄	Bariumsulfate-Turbidity ²	450	262
365	Sulfide	tablet	0.04-0.5	mg/l S ⁻	DPD/Catalyst ^{3,4}	668	264
368	Sulfite 10 T	tablet	0.1-10	mg/l SO ₃	DTNB	405	266
370	Sulfite T	tablet	0.05-4	mg/l SO ₃	DTNB	405	268
375	Surfactants (anionic) TT	tube test	0.05-2	mg/l MBAS	Methylene blue ^{6,1}	653	270
376	Surfactants, TT (anionic)	tube test	0.05-2	mg/l SDSA	Methylene blue ^{6,1}	660	272
377	Surfactants TT (nonionic)	tube test	0.1-7.5	mg/l Triton®X-100	TBPE ⁶	610	274
378	Surfactants TT (cationic)	tube test	0.05-1.5	mg/l CTAB	disulfine blue ^{6,1}	610	276
383	Suspended solids	direct reading	0-750	mg/l TSS	photometric	810	278
380	TOC LR TT	tube test	50-800	mg/l TOC	H ₂ SO ₄ /Persulfate/Indicator ⁶	596	280
381	TOC HR TT	tube test	5.0-80.0	mg/l TOC	H ₂ SO ₄ /Persulfate/Indicator ⁶	596	282
385	Turbidity 50	direct reading	5-500	FAU	Attenuated Radiation Method	860	284
390	Urea T	tablet + liquid	0.1-2	mg/l Urea	Indophenol/Urease	676	286
400	Zinc T	tablet	0.02-0.9	mg/l Zn	Zincon ³	616	288

* = free, combined, total; PP = powder pack; T = tablet;
L = liquid; TT = tube test; LR = low range; MR = middle range; HR = high range;

1.1 Methods

The precision of Lovibond® Reagent Systems (tablets, powder packs and tube tests) is identical to the precision specified in standards literature such as American Standards (AWWA), ISO etc.

Most of the data referred to in these standard methods relates to Standard Solutions. Therefore they are not readily applicable to drinking-, boiler- or waste-water, since various interferences can have a major influence on the accuracy of the method. For this reason we don't state such potentially misleading data.

Due to the fact that each sample is different, the only way to check the tolerances ('precision') is the Standard Additions Method.

According to this method, first the original sample is tested. Then further samples (2 to 4) are taken and small amounts of a Standard Solution are added, and further results are obtained. The amounts added range from approximately half, up to double the amount present in the sample itself.

These supplementary results make it possible to estimate the actual concentration of the original sample by comparison.

Literature

The reagent formulations are based on internationally recognised test methods. Some are described in national and/or international guidelines.

1. Deutsche Einheitsverfahren zur Wasser-, Abwasser- und Schlammuntersuchung
2. Standard methods for the Examination of Water and Wastewater; 18th Edition, 1992
3. Photometrische Analysenverfahren, Schwedt, Wissenschaftliche Verlagsgesellschaft mbH, Stuttgart 1989
4. Photometrische Analyse, Lange / Vejdelek, Verlag Chemie 1980
5. Colorimetric Chemical Analytical methods, 9th Edition, London
6. adapted from Merck, for more information see instructions delivered with the test

Notes for searching:

Active Oxygen	->	Oxygen, activ
Alkalinity-m	->	Alkalinity, total
Alkalinity, total	->	Alkalinity, total
Hazen	->	Colour
Total Hardness	->	Hardness, total
m-Value	->	Alkalinity, total
p-Value	->	Alkalinity-p
Phosphate, reactive	->	Phosphate, ortho
Silicon dioxide	->	Silica

Langelier Saturation Index (Water Balance) -> **Mode function 70**

1.1 Methods

2

0

Acid demand to pH 4.3 with Tablet

0.1 – 4 mmol/l



prepare Zero
press ZERO

1. Fill a clean vial (24 mm Ø) with **10 ml of the water sample**, close tightly with the cap.
2. Place the vial in the sample chamber making sure that the ∇ marks are aligned.
3. Press **ZERO** key.
4. Remove the vial from the sample chamber.
5. Add **one ALKA-M-PHOTOMETER tablet** straight from the foil to the water sample and crush the tablet using a clean stirring rod.
6. Close the vial tightly with the cap and swirl several times until the tablet is dissolved.
7. Place the vial in the sample chamber making sure that the ∇ marks are aligned.
8. Press **TEST** key.

Zero accepted
prepare Test
press TEST

The result is shown in the display as Acid demand to pH 4.3 in mmol/l.

1.1 Methods

Notes:

1. The terms total Alkalinity, Alkalinity-m, m-Value and Acid demand to pH 4.3 are identical.
2. For accurate results exactly 10 ml of water sample must be taken for the test.

Reagent / Accessories	Form of reagent/Quantity	Order-No.
ALKA-M-PHOTOMETER	Tablet / 100	513210BT

1.1 Methods

3

5

Alkalinity-p = p-value with Tablet

5 – 300 mg/l CaCO₃



Ø 24 mm

prepare Zero
press ZERO

1. Fill a clean vial (24 mm Ø) with **10 ml of the water sample**, close tightly with the cap.
2. Place the vial in the sample chamber making sure that the Σ marks are aligned.
3. Press **ZERO** key.
4. Remove the vial from the sample chamber.
5. Add **one ALKA-P-PHOTOMETER tablet** straight from the foil to the water sample and crush the tablet using a clean stirring rod.
6. Close the vial tightly with the cap and swirl several times until the tablet is dissolved.
7. Place the vial in the sample chamber making sure that the Σ marks are aligned.

Wait for a **reaction period of 5 minute**.

Zero accepted
prepare Test
press TEST

8. Press **TEST** key.
The result is shown in the display as Alkalinity-p.

1.1 Methods

Notes

1. The terms Alkalinity-p, p-Value and Alkalinity to pH 8.2 are identical.
2. For accurate test results exactly 10 ml of water sample must be taken for the test.
3. This method was developed from a volumetric procedure for the determination of Alkalinity-p. Due to undefined conditions, the deviations from the standardised method may be greater.
4. Conversion table:

	mg/l CaCO ₃	°dH	°fH	°eH
1 mg/l CaCO ₃	----	0.056	0.10	0.07
1 °dH	17.8	----	1.78	1.25
1 °fH	10.0	0.56	----	0.70
1 °eH	14.3	0.80	1.43	----

- ▲ CaCO₃
- °dH
- °eH
- °fH
- ▼ °aH

5. By determining Alkalinity-p and Alkalinity-m it is possible to classify the alkalinity as Hydroxide, Carbonate and Hydrogencarbonate.

The following differentiation is only valid if:

a) no other alkalis are present and

b) Hydroxide und Hydrogen are not present in the same water sample.

If condition b) is not fulfilled please get additional information from

“Deutsche Einheitsverfahren zur Wasser-, Abwasser- und Schlammuntersuchung, D 8”.

Case 1: Alkalinity-p = 0

Hydrogen carbonate = m

Carbonate = 0

Hydroxide = 0

Case 2: Alkalinity-p > 0 and Alkalinity-m > 2p

Hydrogen carbonate = m – 2p

Carbonate = 2p

Hydroxide = 0

Case 3: Alkalinity-p > 0 and Alkalinity-m < 2p

Hydrogen carbonate = 0

Carbonate = 2m – 2p

Hydroxide = 2p – m

Reagent / Accessories	Form of reagent/Quantity	Order-No.
ALKA-P-PHOTOMETER	Tablet / 100	513230BT

1.1 Methods

3

0

Alkalinity, total = Alkalinity-m = m-Value with Tablet

5 – 200 mg/l CaCO₃

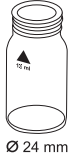

prepare Zero
press ZERO

1. Fill a clean vial (24 mm Ø) with **10 ml of the water sample**, close tightly with the cap.
2. Place the vial in the sample chamber making sure that the Σ marks are aligned.
3. Press **ZERO** key.
4. Remove the vial from the sample chamber.
5. Add **one ALKA-M-PHOTOMETER tablet** straight from the foil to the water sample and crush the tablet using a clean stirring rod.
6. Close the vial tightly with the cap and swirl several times until the tablet is dissolved.
7. Place the vial in the sample chamber making sure that the Σ marks are aligned.
8. Press **TEST** key.

Zero accepted
prepare Test
press TEST

The result is shown in the display as total Alkalinity.

1.1 Methods

Notes:

1. The terms total Alkalinity, Alkalinity-m, m-Value and Alkalinity to pH 4.3 are identical.
2. For accurate results exactly 10 ml of water sample must be taken for the test.
3. Conversion table:

	Acid demand to pH 4.3 DIN 38 409 (K54.3)	German °dH*	English °eH*	French °fH*
1 mg/l CaCO ₃	0.02	0.056	0.07	0.1

*Carbonate hardness (reference = Hydrogencarbonate-anions)

Example:

$$10 \text{ mg/l CaCO}_3 = 10 \text{ mg/l} \times 0.056 = 0.56 \text{ °dH}$$

$$10 \text{ mg/l CaCO}_3 = 10 \text{ mg/l} \times 0.02 = 0.2 \text{ mmol/l}$$

4. ▲ CaCO₃
°dH
°eH
°fH
▼ °aH

Reagent / Accessories	Form of reagent/Quantity	Order-No.
ALKA-M-PHOTOMETER	Tablet / 100	513210BT

1.1 Methods

3

1

Alkalinity HR, total = Alkalinity-m HR = m-Value HR with Tablet

5 – 500 mg/l CaCO₃

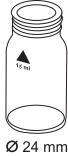

prepare Zero
press ZERO

1. Fill a clean vial (24 mm Ø) with **10 ml of the water sample**, close tightly with the cap.
2. Place the vial in the sample chamber making sure that the Σ marks are aligned.

3. Press **ZERO** key.

4. Remove the vial from the sample chamber.

5. Add **one ALKA-M-HR PHOTOMETER tablet** straight from the foil to the water sample and crush the tablet using a clean stirring rod.

6. Close the vial tightly with the cap and swirl several times until the tablet is dissolved.

Countdown
1:00
start: ↵

7. Press **[↵]** key.
Wait for a **reaction period of 1 minute**.

8. **Remix the solution.**

9. Place the vial in the sample chamber making sure that the Σ marks are aligned.

Zero accepted
prepare Test
press TEST

10. Press **TEST** key.

The result is shown in the display as total Alkalinity.

1.1 Methods

Notes:

1. For verification of the result look carefully at the bottom of the vial. If a thin yellow layer forms, then mix the vial again. This ensures that reaction is complete. Reread the result.
2. Conversion table:

	Acid demand to pH 4.3 DIN 38 409 (K _S 4.3)	German °dH*	English °eH*	French °fH*
1 mg/l CaCO ₃	0.02	0.056	0.07	0.1

* Carbonate hardness (reference = Hydrogencarbonate-anions)

Example:

$$10 \text{ mg/l CaCO}_3 = 10 \text{ mg/l} \times 0.056 = 0.56 \text{ °dH}$$

$$10 \text{ mg/l CaCO}_3 = 10 \text{ mg/l} \times 0.02 = 0.2 \text{ mmol/l}$$

3. ▲ CaCO₃
°dH
°eH
°fH
▼ °aH

Reagent / Accessories	Form of reagent/Quantity	Order-No.
ALKA-M-HR-PHOTOMETER	Tablet / 100	513240BT

1.1 Methods

4

0

Aluminium with Tablet

0.01 – 0.3 mg/l Al



Ø 24 mm

prepare Zero
press ZERO

1. Fill a clean vial (24 mm Ø) with **10 ml of the water sample**, close tightly with the cap.
2. Place the vial in the sample chamber making sure that the Σ marks are aligned.

3. Press **ZERO** key.

4. Remove the vial from the sample chamber.

5. Add **one ALUMINIUM No. 1 tablet** straight from the foil to the water sample and crush the tablet using a clean stirring rod (dissolve the tablet).

6. Add **one ALUMINIUM No. 2 tablet** straight from the foil to the same water sample and crush the tablet using a clean stirring rod.

7. Close the vial tightly with the cap and swirl gently several times until the tablets are dissolved.

8. Place the vial in the sample chamber making sure that the Σ marks are aligned.

9. Press **TEST** key.
Wait for a **reaction period of 5 minutes**.

Zero accepted
prepare Test
press TEST

Countdown
5:00

After the reaction period is finished the measurement starts automatically.

The result is shown in the display in mg/l Aluminium.



1.1 Methods

Notes:

1. Before use clean the vials and the accessories with Hydrochloric acid (approx. 20%).
Rinse them thoroughly with deionised water.
2. To get accurate results the sample temperature must be between 20°C and 25°C.
3. A low test result may be given in the presence of Fluorides and Polyphosphates.
The effect of this is generally insignificant unless the water has fluoride added artificially.
In this case, the following table should be used:

Fluoride [mg/l F]	Displayed value: Aluminium [mg/l Al]					
	0.05	0.10	0.15	0.20	0.25	0.30
0.2	0.05	0.11	0.16	0.21	0.27	0.32
0.4	0.06	0.11	0.17	0.23	0.28	0.34
0.6	0.06	0.12	0.18	0.24	0.30	0.37
0.8	0.06	0.13	0.20	0.26	0.32	0.40
1.0	0.07	0.13	0.21	0.28	0.36	0.45
1.5	0.09	0.20	0.29	0.37	0.48	---

Example: If the result of Aluminium determination is 0.15 mg/l Al and the Fluoride concentration is known to be 0.4 mg/l F, the true concentration of Aluminium is 0.17 mg/l Al.

4. A special tablet ingredient prevents effects on the measurement due to iron and manganese.
5.  Al
 Al₂O₃

Reagent / Accessories	Form of reagent/Quantity	Order-No.
Set ALUMINIUM No. 1 / No. 2	Tablet / per 100 inclusive stirring rod	517601BT
ALUMINIUM No. 1	Tablet / 100	515460BT
ALUMINIUM No. 2	Tablet / 100	515470BT

1.1 Methods

5

0

Aluminium with Vario Powder Pack

0.01 – 0.25 mg/l Al

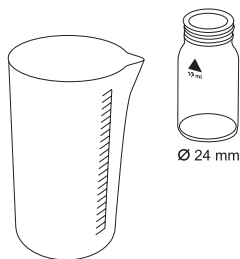

Use two clean vials (24 mm Ø) and mark one as blank for zeroing.

1. Fill **20 ml of water sample** in a 100 ml beaker.
2. Add the contents of **one Vario Aluminium ECR F20 Powder Pack** straight from the foil to the water sample.
3. Dissolve the powder using a clean stirring rod.
4. Press [**↵**] key.
Wait for a **reaction period of 30 seconds**.

Countdown 1
0:30
start: ↵

After the reaction period is finished proceed as follows:

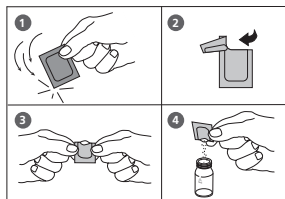

5. Add the contents of **one Vario Hexamine F20 Powder Pack** straight from the foil to the same water sample.
6. Dissolve the powder using a clean stirring rod.
7. Add **1 drop of Vario Aluminium ECR Masking Reagent** in the vial marked as blank.
8. Add 10 ml of the prepared water sample to the vial (**this is the blank**).
9. Add the remaining 10 ml of the prepared water sample in the second clean vial (**this is the sample**).
10. Close the vials tightly with the caps and swirl several times to mix the contents.
11. Press [**↵**] key.
Wait for a **reaction period of 5 minutes**.

Countdown 2
5:00
start: ↵

1.1 Methods

After the reaction period is finished proceed as follows:

- Place the vial (**the blank**) in the sample chamber making sure that the Σ marks are aligned.

prepare Zero
press ZERO

- Press **ZERO** key.

- Remove the vial from the sample chamber.

- Place the vial (**the sample**) in the sample chamber making sure that the Σ marks are aligned.

Zero accepted
prepare Test
press TEST

- Press **TEST** key.

The result is shown in the display in mg/l Aluminium.

Notes:

- Before use clean the vials and the accessories with Hydrochloric acid (approx. 20%). Rinse them thoroughly with deionised water.
- To get accurate results the sample temperature must be between 20°C and 25°C.
- A low test result may be given in the presence of Fluorides and Polyphosphates. The effect of this is generally insignificant unless the water has fluoride added artificially. In this case, the following table should be used:

Fluoride [mg/l F]	Displayed value: Aluminium [mg/l Al]					
	0.05	0.10	0.15	0.20	0.25	0.30
0.2	0.05	0.11	0.16	0.21	0.27	0.32
0.4	0.06	0.11	0.17	0.23	0.28	0.34
0.6	0.06	0.12	0.18	0.24	0.30	0.37
0.8	0.06	0.13	0.20	0.26	0.32	0.40
1.0	0.07	0.13	0.21	0.28	0.36	0.45
1.5	0.09	0.20	0.29	0.37	0.48	---

Example: If the result of Aluminium determination is 0.15 mg/l Al and the Fluoride concentration is known to be 0.4 mg/l F, the true concentration of Aluminium is 0.17 mg/l Al.

- ▲ Al
 ▼ Al₂O₃

Reagent / Accessories	Form of reagent/Quantity	Order-No.
Set VARIO Aluminium ECR F20 VARIO Aluminium Hexamine F 20 VARIO Aluminium ECR Masking Reagent	Powder Pack / 100 Powder Pack / 100 Liquid reagent / 25 ml	535000

1.1 Methods

6

0

Ammonia with Tablet

0.02 – 1 mg/l N



Ø 24 mm

prepare Zero
press ZERO

1. Fill a clean vial (24 mm Ø) with **10 ml of the water sample**, close tightly with the cap.
2. Place the vial in the sample chamber making sure that the Σ marks are aligned.

3. Press **ZERO** key.

4. Remove the vial from the sample chamber.

5. Add **one AMMONIA No. 1 tablet** straight from the foil to the water sample and crush the tablet using a clean stirring rod.

6. Add **one AMMONIA No. 2 tablet** straight from the foil to the same water sample and crush the tablet using a clean stirring rod.

7. Close the vial tightly with the cap and swirl several times until the tablets are dissolved.

8. Place the vial in the sample chamber making sure that the Σ marks are aligned.

9. Press **TEST** key.
Wait for a **reaction period of 10 minutes**.

Zero accepted
prepare Test
press TEST

Countdown
10:00

After the reaction period is finished the measurement starts automatically.

The result is shown in the display in mg/l Ammonia as N.

1.1 Methods

Notes:

1. The tablets must be added in the correct sequence.
2. The AMMONIA No. 1 tablet will only dissolve completely after the AMMONIA No. 2 tablet has been added.
3. The temperature of the sample is important for full colour development.
At a temperature below 20°C the reaction period is 15 minutes.
4. Sea water samples:
Ammonia conditioning reagent is required when testing sea water or brackish water samples to prevent precipitation of salts.
Fill the test tube with the sample to the 10 ml mark and add one level spoonful of Conditioning Powder. Mix to dissolve, then continue as described in the test instructions.
5. Conversion:
 $\text{mg/l NH}_4 = \text{mg/l N} \times 1.29$
 $\text{mg/l NH}_3 = \text{mg/l N} \times 1.22$
6. ▲ N
 NH₄
 ▼ NH₃

Reagent / Accessories	Form of reagent/Quantity	Order-No.
Set AMMONIA No. 1 / No. 2	Tablet / per 100 inclusive stirring rod	517611BT
AMMONIA No. 1	Tablet / 100	512580BT
AMMONIA No. 2	Tablet / 100	512590BT
Ammonia conditioning reagent (Sea water samples)	(approx. 50 tests) powder / 15 g	460170

1.1 Methods

6

2

Ammonia with Vario Powder Pack

0.01 – 0.8 mg/l N



Ø 24 mm

Use two clean vials (24 mm Ø) and mark one as blank for zeroing.

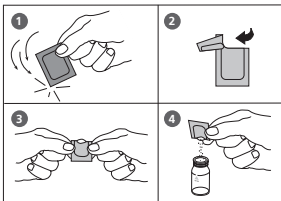

Countdown
3:00
start: ↓

1. Fill a clean vial (24 mm Ø) with **10 ml of deionised water** (this is the blank).
2. Fill the other clean vial (24 mm Ø) with **10 ml of the water sample** (this is the sample).
3. Add the contents of **one Vario Ammonia Salicylate F10 Powder Pack** straight from the foil to each vial.
4. Close the vials tightly with the caps and swirl several times to mix the contents.
5. Press [↓] key.
Wait for a **reaction period of 3 minutes**.

After the reaction period is finished proceed as follows:

6. Add the contents of **one Vario Ammonia Cyanurate F10 Powder Pack** straight from the foil to each sample.
7. Close the vials tightly with the caps and shake thoroughly until the reagent is dissolved completely.
8. Press [↓] key.
Wait for a **reaction period of 15 minutes**.

After the reaction period is finished proceed as follows:

9. Place the vial (the blank) in the sample chamber making sure that the Σ marks are aligned.
10. Press **ZERO** key.
11. Remove the vial from the sample chamber.
12. Place the vial (the sample) in the sample chamber making sure that the marks Σ are aligned.
13. Press **TEST** key.

The result is shown in the display in mg/l Ammonia as N.

Countdown
15:00
start: ↓

prepare Zero
press ZERO

Zero accepted
prepare Test
press TEST

1.1 Methods

Notes:

- Extremely basic or acidic water samples should be adjusted with 0.5 mol/l (1 N) Sulfuric acid solution or 1 mol/l (1 N) Sodium hydroxide solution to pH 7.
- Interferences:

Interfering substance	Interference levels and treatments
Calcium	greater than 1000 mg/l CaCO_3
Iron	Interferes at all levels. Correct as follows: a) determine the concentration of iron present in the sample by performing a total Iron test b) add the same iron concentration as determined to the deionised water (step 1). The interference will be blanked out successfully.
Magnesium	greater than 6000 mg/l CaCO_3
Nitrate	greater than 100 mg/l $\text{NO}_3\text{-N}$
Nitrite	greater than 12 mg/l $\text{NO}_2\text{-N}$
Phosphate	greater than 100 mg/l $\text{PO}_4\text{-P}$
Sulfate	greater than 300 mg/l SO_4
Sulfide	intensifies the colour
Glycine, Hydrazine, Colour, Turbidity	Less common interferences such as Hydrazine and Glycine will cause intensified colours in the prepared sample. Turbidity and colour will give erroneous high values. Samples with severe interferences require distillation.

3. ▲ N
 ▼ NH_4
 NH_3

Reagent / Accessories	Form of reagent/Quantity	Order-No.
Set VARIO Ammonia Salicylate F10 VARIO Ammonia Cyanurate F10	Powder Pack / per 100 PP	535500

1.1 Methods

6

5

Ammonia LR with Vario Tube Test

0.02 – 2.5 mg/l N

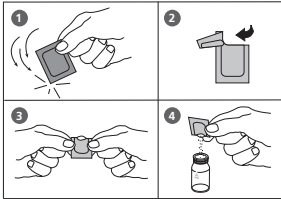
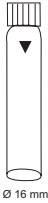

1. Open one white capped reaction vial and add **2 ml deionised water** (this is the blank).
2. Open another white capped reaction vial and add **2 ml water sample** (this is the sample).
3. Add the contents of **one Vario Ammonia Salicylate F5 Powder Pack** straight from the foil into each vial.
4. Add the contents of **one Vario Ammonia Cyanurate F5 Powder Pack** straight from the foil into each vial.
5. Close the vials tightly with the caps and shake thoroughly until the reagent is dissolved completely.
6. Press **[↓]** key.
Wait for a **reaction period of 20 minutes**.

Countdown
20:00
start: ↓

After the reaction period is finished proceed as follows:

7. Place the vial (the blank) in the sample chamber making sure that the marks are Δ aligned.
8. Press **ZERO** key.
9. Remove the vial from the sample chamber.
10. Place the vial (the sample) in the sample chamber making sure that the marks are Δ aligned.
11. Press **TEST** key.

The result is shown in the display in mg/l Ammonia as N.

prepare Zero
press ZERO

Zero accepted
prepare Test
press TEST

1.1 Methods

Notes:

1. Strong alkaline or acidic water samples must be adjusted to approx. pH 7 before analysis (use 1 mol/l Hydrochloric acid resp. 1 mol/l Sodium hydroxide).
2. Iron interferes with the test. The interferences will be eliminated as follows:
Determine the amount of total iron present in the water sample. To produce the blank add an iron standard solution with the same iron concentration to the vial (point 1) instead of deionised water.
3. Conversion:
 $\text{mg/l NH}_4 = \text{mg/l N} \times 1.29$
 $\text{mg/l NH}_3 = \text{mg/l N} \times 1.22$
4. ▲ N
 NH₄
 ▼ NH₃

Reagent / Accessories	Form of reagent/Quantity	Order-No.
Set VARIO Ammonia Salicylate F5 VARIO Ammonia Cyanurate F5 VARIO Am Diluent Reagent LR VARIO deionised water	Set Powder Pack / 50 Powder Pack / 50 Reaction tube / 50 100 ml	535600

1.1 Methods

6

6

Ammonia HR with Vario Tube Test

1 – 50 mg/l N

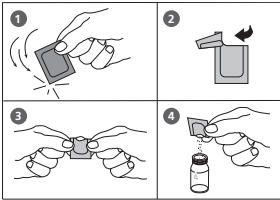

1. Open one white capped reaction vial and add **0.1 ml deionised water** (this is the blank).
2. Open another white capped reaction vial and add **0.1 ml of water sample** (this is the sample).
3. Add the contents of **one Vario Ammonia Salicylate F5 Powder Pack** straight from the foil into each vial.
4. Add the contents of **one Vario Ammonia Cyanurate F5 Powder Pack** straight from the foil into each vial.
5. Close the vials tightly with the caps and shake thoroughly until the reagent is dissolved completely.
6. Press **[↵]** key.
Wait for a **reaction period of 20 minutes**.

Countdown
20:00
start: ↵

After the reaction period is finished proceed as follows:

7. Place the vial (the blank) in the sample chamber making sure that the marks are **Δ** aligned.
8. Press **ZERO** key.
9. Remove the vial from the sample chamber.
10. Place the vial (the sample) in the sample chamber making sure that the marks are **Δ** aligned.
11. Press **TEST** key.

The result is shown in the display in mg/l Ammonia as N.

prepare Zero
press ZERO

Zero accepted
prepare Test
press TEST

1.1 Methods

Notes:

1. Strong alkaline or acidic water samples must be adjusted to approx. pH 7 before analysis (use 1 mol/l Hydrochloric acid resp. 1 mol/l Sodium hydroxide).
2. If chlorine is known to be present, add one drop of 0.1 mol/l Sodium thiosulfate for each 0.3 mg/l Cl₂ in a one litre water sample.
3. Iron interferes with the test. The interferences will be eliminated as follows:
Determine the amount of total iron present in the water sample. Add an iron standard solution with the same concentration to the vial (point 1) instead of deionised water to produce the blank.
4. Conversion:

$$\text{mg/l NH}_4 = \text{mg/l N} \times 1.29$$

$$\text{mg/l NH}_3 = \text{mg/l N} \times 1.22$$
5. ▲ N
 NH₄
 ▼ NH₃

Reagent / Accessories	Form of reagent/Quantity	Order-No.
Set VARIO Ammonia Salicylate F5 VARIO Ammonia Cyanurate F5 VARIO Am Diluent Reagent HR VARIO deionised water	Set Powder Pack / 50 Powder Pack / 50 Reaction tube / 50 100 ml	535650

1.1 Methods

6

8

Arsenic

0.02 – 0.6 mg/l As

Reagents (note 2):

- 40 % Sulfuric Acid (H_2SO_4) p.a.
- Dissolve 8.33 g Potassium Iodide (KI) p.a. in 50 ml of deionised water
Note: stored in a dark bottle it can be used for 1 week
- Dissolve 4.0 g Tin(II)-chloride-Dihydrate ($SnCl_2 \cdot 2H_2O$) p.a. in 10 ml Hydrochloric Acid (HCl) 25 % p.a.
- 2.0 g Zinc coarse powder (Zn; particle size about 0.3-1.5 mm) p.a.
- Absorption solution:
Dissolve 0.25 g Silver diethyldithiocarbamate ($C_5H_{10}AgNS_2$) p.a.
and
0.02 g Brucine ($C_{23}H_{26}N_2O_4$) p.a. in
100 ml 1-Methyl-2-pyrrolidone extra pure (C_5H_9NO)
and store in a dark bottle.
If it is not possible to dissolve completely, stir for min.
1 hour and filtrate to get a clear solution.

Notes:

- use only dry glass vessels
- stored in a dark glass bottle at max. 20°C the absorption solution can be used for about 1 week
- store Silver diethyldithiocarbamate at 4°C.

Part list for glass apparatus:

- 100 ml Erlenmeyer flask (NS29/32) Order code: 37 05 01
- glass stopper (NS29/32) Order code: 37 05 02
- absorption tube (NS29,2/32) Order code: 37 05 03

Assembling of apparatus:

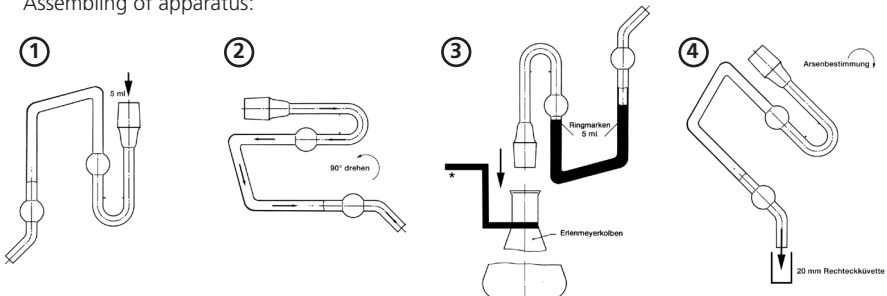

* Durch geeignete Befestigung vor Umkippen sichern

1.1 Methods

Sample preparation: Reaction times must be exactly kept!

1. Prepare the **dry** reaction apparatus (note 4) and place it under a fume hood (toxic fumes!).
2. Pipette **50 ml of water sample** into a 100 ml Erlenmeyer flask (NS 29/32).
3. **30 ml Sulfuric Acid, 2.0 ml Potassium Iodide solution and 0.3 ml Tin(II)chloride** are added to the water sample.
4. Close the flask and shake, wait for a period of **15 minutes**.
5. Prepare **2.0 g Zinc**.
6. Fill the absorption tube with exact **5.0 ml of absorption solution** (see picture ① and ②; use pipette).
7. After end of the 15 minutes reaction time add the 2 g Zinc to the Erlenmeyer flask and **immediately assemble** the apparatus with the prepared absorption tube (see picture ③).
8. The reaction starts (**fume hood!**). Wait for **60 minutes** reaction time.



**prepare Zero
press ZERO**

Performing test procedure:

9. Fill a clean **20 mm cell** (note 1) with **deionised water**.
10. Place the cell in the sample chamber making sure that the positioning is correct.
11. Press **ZERO** key.
12. After zeroing remove the cell from the sample chamber. Empty the cell and dry completely.
13. Fill the cell with the coloured absorption solution. (see picture ④).
14. Place the cell in the sample chamber making sure that the marks are aligned.
15. Press **TEST** key.

The result is shown in the display in mg/l Arsenic.

**Zero accepted
prepare Test
press TEST**

1.1 Methods

Notes:

1. Appropriate safety precautions and a good lab technique must be used during the whole procedure.
2. Reagents are commercially and should ordered locally.
MSDS: please refer to your local reagent supplier. Ensure proper disposal of reagent solution.
3. Use a cell with 20 mm path length. Order code: 60 10 50.
Positioning: insert cell on the left side in the sample chamber (c = clip).

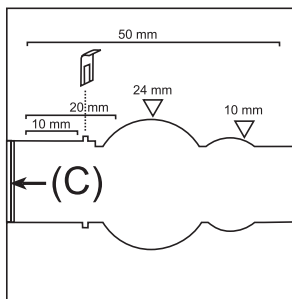

4. According to literature (G. Ackermann, J. Köthe: Fresenius Z. Anal. Chem. 323 (1986), 135) Sb, Se and Te interfere due to the same reaction; Thiosulfate interferes differently.

1.1 Methods

8

5

Boron with Tablet

0.1 – 2 mg/l B



Ø 24 mm

prepare Zero
press ZERO

1. Fill a clean vial (24 mm Ø) with **10 ml of the water sample**, close tightly with the cap.
2. Place the vial in the sample chamber making sure that the Σ marks are aligned.
3. Press **ZERO** key.
4. Remove the vial from the sample chamber.
5. Add **one BORON No. 1 tablet** straight from the foil to the water sample and crush the tablet using a clean stirring rod and dissolve the tablet.
6. Add **one BORON No. 2 tablet** straight from the foil to the same water sample and crush the tablet using a clean stirring rod.
7. Close the vial tightly with the cap and swirl several times until the tablets are dissolved.
8. Place the vial in the sample chamber making sure that the Σ marks are aligned.
9. Press **TEST** key.

Zero accepted
prepare Test
press TEST

Countdown
20:00

Wait for a **reaction period of 20 minutes**.

After the reaction period is finished the measurement starts automatically.

The result is shown in the display in mg/l Boron.

1.1 Methods

Notes:

1. The tablets must added in the correct sequence.
2. The sample solution should have a pH value between 6 and 7.
3. Interferences are prevented by the presence of EDTA in the tablets.
4. The rate of colour development depends on the temperature. The temperature of the sample must be $20^{\circ}\text{C} \pm 1^{\circ}\text{C}$.

5. ▲ B
▼ H_3BO_3

Reagent / Accessories	Form of reagent/Quantity	Order-No.
Set Bor No. 1 / No. 2	Tablet / per 100 inclusive stirring rod	517681BT
BORON No. 1	Tablet / 100	515790
BORON No. 2	Tablet / 100	515800BT

1.1 Methods

7

8

Bromine with Tablet

0.1 – 3 mg/l Br₂



10 mm

prepare Zero
press ZERO

1. Fill a clean 10 mm cell with **water sample**.
2. Place the cell in the sample chamber making sure that the positioning is correct.
3. Press **ZERO** key.
4. Remove the cell from the sample chamber. Empty the cell and dry completely.
5. Rinse a beaker with the water sample and **empty it, leaving a few drops remaining in the beaker**.
6. Add **one DPD No. 1 tablet** straight from the foil and crush the tablet using a clean stirring rod.
7. Add **10 ml of water sample** and dissolve the tablet.
8. Fill the 10 mm cell with the coloured test solution.
9. Place the cell in the sample chamber making sure that the positioning is correct.
10. Press **TEST** key.

Zero accepted
prepare Test
press TEST

The result is shown in the display in mg/l Bromine.

1.1 Methods

Notes:

1. Vial cleaning:
As many household cleaners (e.g. dishwasher detergent) contain reducing substances, the subsequent determination of Bromine may show lower results. To avoid any measurement errors, only use glassware free of Chlorine demand.
Preparation: Put all applicable glassware into Sodium hypochlorite solution (0.1 g/l) for one hour, then rinse all glassware thoroughly with deionised water.
2. Preparing the sample:
When preparing the sample, the loss of Bromine, e.g. by pipetting or shaking, must be avoided. The analysis must take place immediately after taking the sample.
3. The DPD colour development is carried out at a pH value of 6.2 to 6.5. The reagent tablet therefore contains a buffer for pH adjustment. Strong alkaline or acidic water samples must be adjusted between pH 6 and pH 7 before the reagent is added (use 0.5 mol/l Sulfuric acid resp. 1 mol/l Sodium hydroxide).
4. Exceeding the measuring range:
Concentrations above 22 mg/l Bromine can lead to results showing 0 mg/l. In this case, the water must be diluted with water free of Bromine. 10 ml of the diluted sample should be mixed with the reagent and the measurement repeated.
5. Oxidising agents such as Chlorine, Ozone etc. interfere as they react in the same way as Bromine.

Reagent / Accessories	Form of reagent/Quantity	Order-No.
DPD No. 1	Tablet / 100	511050BT

1.1 Methods

7 9

Bromine with Tablet

0.05 – 1 mg/l Br₂

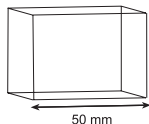

prepare Zero
press ZERO

1. Fill a clean 50 mm cell with **water sample**.
2. Place the cell in the sample chamber making sure that the positioning is correct.
3. Press **ZERO** key.
4. Remove the cell from the sample chamber. Empty the cell and dry completely.
5. Rinse a beaker with the water sample and **empty it, leaving a few drops remaining in the beaker**.
6. Add **one DPD No. 1 tablet** straight from the foil and crush the tablet using a clean stirring rod.
7. Add **10 ml of water sample** and dissolve the tablet.
8. Fill the 50 mm cell with the coloured test solution.
9. Place the cell in the sample chamber making sure that the positioning is correct.
10. Press **TEST** key.

Zero accepted
prepare Test
press TEST

The result is shown in the display in mg/l Bromine.

1.1 Methods

Notes:

1. Vial cleaning:
As many household cleaners (e.g. dishwasher detergent) contain reducing substances, the subsequent determination of Bromine may show lower results. To avoid any measurement errors, only use glassware free of Chlorine demand.
Preparation: Put all applicable glassware into Sodium hypochlorite solution (0.1 g/l) for one hour, then rinse all glassware thoroughly with deionised water.
2. Preparing the sample:
When preparing the sample, the loss of Bromine, e.g. by pipetting or shaking, must be avoided. The analysis must take place immediately after taking the sample.
3. The DPD colour development is carried out at a pH value of 6.2 to 6.5. The reagent tablet therefore contains a buffer for pH adjustment. Strong alkaline or acidic water samples must be adjusted between pH 6 and pH 7 before the reagent is added (use 0.5 mol/l Sulfuric acid resp. 1 mol/l Sodium hydroxide).
4. Exceeding the measuring range:
Concentrations above 22 mg/l Bromine can lead to results showing 0 mg/l. In this case, the water must be diluted with water free of Bromine. 10 ml of the diluted sample should be mixed with the reagent and the measurement repeated.
5. Oxidising agents such as Chlorine, Ozone etc. interfere as they react in the same way as Bromine.

Reagent / Accessories	Form of reagent/Quantity	Order-No.
DPD No. 1	Tablet / 100	511050BT

1.1 Methods

8

0

Bromine with Tablet

0.05 – 6.5 mg/l Br₂



prepare Zero
press ZERO

1. Fill a clean vial (24 mm Ø) with **10 ml of the water sample**, close tightly with the cap.
2. Place the vial in the sample chamber making sure that the Σ marks are aligned.
3. Press **ZERO** key.
4. Remove the vial from the sample chamber and **empty it, leaving a few drops remaining in the vial.**
5. Add **one DPD No. 1 tablet** straight from the foil and crush the tablet using a clean stirring rod.
6. Add water sample to the 10 ml mark.
7. Close the vial tightly with the cap and swirl several times until the tablet is dissolved.
8. Place the vial in the sample chamber making sure that the Σ marks are aligned.

Zero accepted
prepare Test
press TEST

9. Press **TEST** key.

The result is shown in the display in mg/l Bromine.

1.1 Methods

Notes:

1. Vial cleaning:
As many household cleaners (e.g. dishwasher detergent) contain reducing substances, the subsequent determination of Bromine may show lower results. To avoid any measurement errors, only use glassware free of Chlorine demand.
Preparation: Put all applicable glassware into Sodium hypochlorite solution (0.1 g/l) for one hour, then rinse all glassware thoroughly with deionised water.
2. Preparing the sample:
When preparing the sample, the loss of Bromine, e.g. by pipetting or shaking, must be avoided. The analysis must take place immediately after taking the sample.
3. The DPD colour development is carried out at a pH value of 6.2 to 6.5. The reagent tablet therefore contains a buffer for pH adjustment. Strong alkaline or acidic water samples must be adjusted between pH 6 and pH 7 before the reagent is added (use 0.5 mol/l Sulfuric acid resp. 1 mol/l Sodium hydroxide).
4. Exceeding the measuring range:
Concentrations above 22 mg/l Bromine can lead to results showing 0 mg/l. In this case, the water must be diluted with water free of Bromine. 10 ml of the diluted sample should be mixed with the reagent and the measurement repeated.
5. Oxidising agents such as Chlorine, Ozone etc. interfere as they react in the same way as Bromine.

Reagent / Accessories	Form of reagent/Quantity	Order-No.
DPD No. 1	Tablet / 100	511050BT

1.1 Methods

8

7

Cadmium with MERCK Spectroquant® Cell Test, Nr. 1.14834.0001

0,025 – 0,75 mg/l Cd / 25 – 750 µg/l Cd



∅ 16 mm

Use two clean Reagent tubes and mark one as blank for zeroing.

1. Add **5 ml deionised water** in the vial marked as blank **(this is the blank, note 6)**.
2. Fill the second prepared vial with **5 ml of the water sample (this is the test solution, note 6)**.
3. Close the vials tightly with the caps and invert several times to mix the contents.
4. Pipette **0.2 ml reagent Cd-1K** into each vial. **(Note 6)**
5. Close the vials tightly with the caps and invert several times to mix the contents.
6. Add **one level microspoon of Cd - 2K** into each vial.
7. Close the vials tightly with the caps and swirl vigorously until the reagent is dissolved completely.
8. Place the vial **(the blank)** in the sample chamber making sure that the Δ marks are aligned.
9. Press **ZERO** key.
10. Remove the vial from the sample chamber.
11. Place the vial **(the sample)** in the sample chamber making sure that the Δ marks are aligned.

**prepare Zero
press ZERO**

1.1 Methods

Zero accepted
prepare Test
press TEST

Countdown
2:00

12. Press **TEST** key.

Wait for a **reaction period of 2 minutes**.

After the reaction period is finished the measurement starts automatically.

The result is shown in the display as Cadmium.

Notes:

1. This method is adapted from MERCK.
2. Before performing the test read the original test instructions (delivered with the test) and the MSDS (available at www.merckmillipore.com).
3. Spectroquant® is a registered trade mark of the company MERCK KGaA.
4. Appropriate safety precautions and good lab technique should be used during the whole procedure.
5. Because reaction depends on temperature, the **sample temperature must be between 10 and 40°C**.
6. Sample and reagent volumes should always be metered by using volumetric pipettes (class A).
7. This test determines only Cd²⁺-ions. Samples must be pre-treated or decomposed by digestion before undissolved and complex-bound cadmium can be measured.
8. Store the reagents in closed containers at a temperature of + 15°C to + 25°C.
9. The test sample should have a pH of between 3 and 11.
10. ▲ mg/l
 ▼ µg/l

Reagent / Accessories	Form of reagent/Quantity	Order-No.
MERCK Spectroquant® 1.14834.0001	Cell Test / 25 Tests	420750

1.1 Methods

9

0

Chloride with Tablet

0.5 – 25 mg/l Cl⁻



Ø 24 mm

prepare Zero
press ZERO

1. Fill a clean vial (24 mm Ø) with **10 ml of the water sample**, close tightly with the cap.
2. Place the vial in the sample chamber making sure that the Σ marks are aligned.
3. Press **ZERO** key.
4. Remove the vial from the sample chamber.
5. Add **one CHLORIDE T1 tablet** straight from the foil to the water sample, crush the tablet using a clean stirring rod and dissolve the tablet.
6. Add **one CHLORIDE T2 tablet** straight from the foil to the same water sample and crush the tablet using a clean stirring rod.
7. Close the vial tightly with the cap and swirl gently several times until the tablet is dissolved (Note 1).
8. Place the vial in the sample chamber making sure that the Σ marks are aligned.
9. Press **TEST** key.

Zero accepted
prepare Test
press TEST

Countdown
2:00

Wait for a **reaction period of 2 minutes**.

After the reaction period is finished the measurement starts automatically.

The result is shown in the display in mg/l Chloride.

1.1 Methods

Notes:

1. Ensure that all particles of the tablet are dissolved – Chloride causes an extremely fine distributed turbidity with a milky appearance.
Heavy shaking leads to bigger sized particles which can cause false readings.
2. High concentrations of electrolytes and organic compounds have different effects on the precipitation reaction.
3. Ions which also form deposits with Silver nitrate in acidic media, such as Bromides, Iodides and Thiocyanates, interfere with the analysis.
4. Highly alkaline water should – if necessary – be neutralised using Nitric acid before analysis.
5. Conversion:
 $\text{mg/l NaCl} = \text{mg/l Cl}^- \times 1,65$
6. ▲ Cl⁻
▼ NaCl

Reagent / Accessories	Form of reagent/Quantity	Order-No.
Set CHLORIDE T1 / T2	Tablet / per 100 inclusive stirring rod	517741BT
CHLORIDE T1	Tablet / 100	515910BT
CHLORIDE T2	Tablet / 100	515920BT

1.1 Methods

9

1

Chloride with Reagent Test

5 – 60 mg/l Cl⁻



Ø 24 mm

Use two clean vials (24 mm Ø) and mark one as blank for zeroing.

1. Fill a clean vial (24 mm Ø) with **10 ml of deionised water** (this is the blank).
2. Fill the second clean vial (24 mm Ø) with **1 ml of the water sample** and **9 ml of deionised water** (this is the sample).
3. Fill each vial with drops of the same size by holding the bottle vertically and squeeze slowly:

3 drops Chloride-51

4. Close the vials tightly with the caps and invert several times to mix the contents.
5. Fill each vial with drops of the same size by holding the bottle vertically and squeeze slowly:

3 drops Chlorid-52

6. Close the vials tightly with the caps and invert several times to mix the contents.

Countdown
3:00
start: ↓

7. Press **[↓]** key.
Wait for a **reaction period of 3 minutes**.
8. Place the vial (the blank) in the sample chamber making sure that the Σ marks are aligned.
9. Press **ZERO** key.
10. Remove the vial from the sample chamber.
11. Place the vial (the sample) in the sample chamber making sure that the Σ marks are aligned.
12. Press **TEST** key.

prepare Zero
press ZERO

Zero accepted
prepare Test
press TEST

The result is shown in the display in mg/l Chloride.

1.1 Methods

Notes:

1. The test sample and the reagents should have room temperature for test performance.
2. The test sample should have a pH of between 3 and 9.
- 3. Store the reagent bottles in a cool, dry place ideally at between 4°C and 8°C.**
4. Interferences: Thiocyanate, Sulfide, Thiosulfate, Bromide and Iodide interfere because they react in the same way as Chloride.
5. ▲ Cl⁻
▼ NaCl

Reagent / Accessories	Form of reagent/Quantity	Order-No.
SET: CHLORIDE-51 CHLORIDE-52	Reagent Test (Liquid reagent) / approx. 50-75 Tests	2419031

1.1 Methods

9 8

Chlorine with Tablet

0.1 – 6 mg/l Cl₂



9 9

Chlorine with Tablet

0.02 – 0.5 mg/l Cl₂

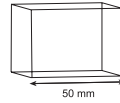

1 0 0

Chlorine with Tablet

0.02 – 3 mg/l Cl₂



1 0 4

Chlorine with Tablet

0.1 – 10 mg/l Cl₂

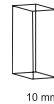

1 0 1

Chlorine with Liquid Reagent

0.02 – 3 mg/l Cl₂



1 1 0

Chlorine with Powder Pack

0.01 – 2 mg/l Cl₂



1 1 3

Chlorine MR with Vario Powder Pack

0.01 – 3.5 mg/l Cl₂



Chlorine

>> diff
>> free
>> total

The following selection is shown in the display:

>> diff

for the differentiated determination of free, combined and total Chlorine

>> free

for the determination of free Chlorine

>> total

for the determination of total Chlorine

Select the desired determination with the arrow keys [▲] and [▼]. Confirm with [↵] key.

1.1 Methods

Notes:

1. Vial cleaning:
As many household cleaners (e.g. dishwasher detergent) contain reducing substances, the subsequent determination of Chlorine may show lower results. To avoid any measurement errors, only use glassware free of Chlorine demand.
Preparation: Put all applicable glassware into Sodium hypochlorite solution (0.1 g/l) for one hour, then rinse all glassware thoroughly with deionised water.
 2. For individual testing of free and total Chlorine, the use of different sets of glassware is recommended (EN ISO 7393-2, 5.3)
 3. Preparing the sample:
When preparing the sample, the loss of Chlorine, e.g. by pipetting or shaking, must be avoided. The analysis must take place immediately after taking the sample.
 4. The DPD colour development is carried out at a pH value of 6.2 to 6.5. The reagents therefore contain a buffer for the pH adjustment.
Strong alkaline or acidic water samples must be adjusted between pH 6 and pH 7 before the reagent is added (use 0.5 mol/l Sulfuric acid resp. 1 mol/l Sodium hydroxide).
- Exceeding the measuring range:
- Concentrations above
- 10 mg/l Chlorine using tablets (methods 98, 99, 100)
 - 4 mg/l Chlorine using liquid reagents (methods 101)
 - 2 mg/l using powder packs (methods 110)
 - 2 mg/l using powder packs (methods 113)
- can lead to results showing 0 mg/l. In this case, the water sample must be diluted with water free of Chlorine. 10 ml of the diluted sample should be mixed with the reagent and the measurement repeated.
5. Turbidity (can lead to errors):
The use of the reagent tablets (method 98, 99, 100) in samples with high Calcium ion contents* and/or high conductivity* can lead to turbidity of the sample and therefore incorrect measurements. In this case, the reagent tablets DPD No. 1 High Calcium and DPD No. 3 High Calcium should be used as an alternative.
** it is not possible to give exact values, because the development of turbidity depends on the nature of the sample.*
 6. If **???** is displayed at a differentiated test result see page 356.
 7. Oxidising agents such as Bromine, Ozone etc. interfere as they react in the same way as Chlorine.

1.1 Methods

9

8

Chlorine, differentiated determination with Tablet

0.1 – 6 mg/l Cl₂



10 mm

prepare Zero
press ZERO

Zero accepted
prepare T1
press TEST

T1 accepted
prepare T2
press TEST

Countdown
2:00

*** mg/l free Cl
*** mg/l comb Cl
*** mg/l tot Cl

1. Fill a clean 10 mm cell with **water sample**.
2. Place the cell in the sample chamber making sure that the positioning is correct.
3. Press **ZERO** key.
4. Remove the cell from the sample chamber. Empty the cell and dry completely.
5. Rinse a beaker with the water sample and **empty it, leaving a few drops remaining in the beaker**.
6. Add **one DPD No. 1 tablet** straight from the foil and crush the tablet using a clean stirring rod.
7. Add **10 ml of water sample** and dissolve the tablet.
8. Fill the 10 mm cell with the coloured test solution.
9. Place the cell in the sample chamber making sure that the positioning is correct.
10. Press **TEST** key.
11. Remove the cell from the sample chamber and return the coloured test solution completely back into the beaker.
12. Add **one DPD No. 3 tablet** straight from the foil to the same water sample and crush the tablet using a clean stirring rod. Dissolve the tablet.
13. Fill the 10 mm cell with the coloured test solution.
14. Place the cell in the sample chamber making sure that the positioning is correct.
15. Press **TEST** key.

Wait for a **reaction period of 2 minutes**.

After the reaction period is finished the measurement starts automatically.

The result is shown in the display in:

mg/l free Chlorine
mg/l combined Chlorine
mg/l total Chlorine

1.1 Methods

9 8

Chlorine, free with Tablet

0.1 – 6 mg/l Cl₂



10 mm

**prepare Zero
press ZERO**

1. Fill a clean 10 mm cell with **water sample**.
2. Place the cell in the sample chamber making sure that the positioning is correct.
3. Press **ZERO** key.
4. Remove the cell from the sample chamber. Empty the cell and dry completely.
5. Rinse a beaker with the water sample and **empty it, leaving a few drops remaining in the beaker**.
6. Add **one DPD No. 1 tablet** straight from the foil and crush the tablet using a clean stirring rod.
7. Add **10 ml of water sample** and dissolve the tablet.
8. Fill the 10 mm cell with the coloured test solution.
9. Place the cell in the sample chamber making sure that the positioning is correct.
10. Press **TEST** key.

**Zero accepted
prepare Test
press TEST**

The result is shown in the display in mg/l free Chlorine.

Notes:

see page 55

1.1 Methods

9

8

Chlorine, total with Tablet

0.1 – 6 mg/l Cl₂



10 mm

prepare Zero
press ZERO

1. Fill a clean 10 mm cell with **water sample**.
2. Place the cell in the sample chamber making sure that the positioning is correct.
3. Press **ZERO** key.
4. Remove the cell from the sample chamber. Empty the cell and dry completely.
5. Rinse a beaker with the water sample and **empty it, leaving a few drops remaining in the beaker**.
6. Add **one DPD No. 1 and one DPD No. 3 tablet** straight from the foil and crush the tablet using a clean stirring rod.
7. Add **10 ml of water sample** and dissolve the tablet.
8. Fill the 10 mm cell with the coloured test solution.
9. Place the cell in the sample chamber making sure that the positioning is correct.
10. Press **TEST** key.
Wait for a **reaction period of 2 minutes**.

Zero accepted
prepare Test
press TEST

Countdown
2:00

After the reaction period is finished the measurement starts automatically.

The result is shown in the display in mg/l total Chlorine.

Notes:

see page 55

1.1 Methods



Chlorine, differentiated determination with Tablet

0.02 – 0.5 mg/l Cl₂

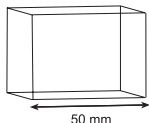

prepare Zero
press ZERO

Zero accepted
prepare T1
press TEST

T1 accepted
prepare T2
press TEST

Countdown
2:00

*,** mg/l free Cl
*,** mg/l comb Cl
*,** mg/l tot Cl

1. Fill a clean 50 mm cell with **water sample**.
2. Place the cell in the sample chamber making sure that the positioning is correct.
3. Press **ZERO** key.
4. Remove the cell from the sample chamber. Empty the cell and dry completely.
5. Rinse a beaker with the water sample and **empty it, leaving a few drops remaining in the beaker**.
6. Add **one DPD No. 1 tablet** straight from the foil and crush the tablet using a clean stirring rod.
7. Add **10 ml of water sample** and dissolve the tablet.
8. Fill the 50 mm cell with the coloured test solution.
9. Place the cell in the sample chamber making sure that the positioning is correct.
10. Press **TEST** key.
11. Remove the cell from the sample chamber and return the coloured test solution completely back into the beaker.
12. Add **one DPD No. 3 tablet** straight from the foil to the same water sample and crush the tablet using a clean stirring rod. Dissolve the tablet.
13. Fill the 50 mm cell with the coloured test solution.
14. Place the cell in the sample chamber making sure that the positioning is correct.
15. Press **TEST** key.

Wait for a **reaction period of 2 minutes**.

After the reaction period is finished the measurement starts automatically.

The result is shown in the display in:

mg/l free Chlorine
mg/l combined Chlorine
mg/l total Chlorine

1.1 Methods

9

9

Chlorine, free with Tablet

0.02 – 0.5 mg/l Cl₂

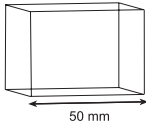

prepare Zero
press ZERO

1. Fill a clean 50 mm cell with **water sample**.
2. Place the cell in the sample chamber making sure that the positioning is correct.
3. Press **ZERO** key.
4. Remove the cell from the sample chamber. Empty the cell and dry completely.
5. Rinse a beaker with the water sample and **empty it, leaving a few drops remaining in the beaker**.
6. Add **one DPD No. 1 tablet** straight from the foil and crush the tablet using a clean stirring rod.
7. Add **10 ml of water sample** and dissolve the tablet.
8. Fill the 50 mm cell with the coloured test solution.
9. Place the cell in the sample chamber making sure that the positioning is correct.
10. Press **TEST** key.

Zero accepted
prepare Test
press TEST

The result is shown in the display in mg/l free Chlorine.

Notes:

see page 55

1.1 Methods



Chlorine, total with Tablet

0.02 – 0.5 mg/l Cl₂

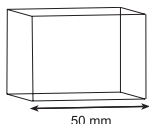

prepare Zero
press ZERO

1. Fill a clean 50 mm cell with **water sample**.
2. Place the cell in the sample chamber making sure that the positioning is correct.
3. Press **ZERO** key.
4. Remove the cell from the sample chamber. Empty the cell and dry completely.
5. Rinse a beaker with the water sample and **empty it, leaving a few drops remaining in the beaker**.
6. Add **one DPD No. 1 and one DPD No. 3 tablet** straight from the foil and crush the tablet using a clean stirring rod.
7. Add **10 ml of water sample** and dissolve the tablet.
8. Fill the 50 mm cell with the coloured test solution.
9. Place the cell in the sample chamber making sure that the positioning is correct.

Zero accepted
prepare Test
press TEST

Countdown
2:00

10. Press **TEST** key.
Wait for a **reaction period of 2 minutes**.

After the reaction period is finished the measurement starts automatically.

The result is shown in the display in mg/l total Chlorine.

1.1 Methods



Chlorine, free with Tablet

0.02 – 3 mg/l Cl₂



prepare Zero
press ZERO

1. Fill a clean vial (24 mm Ø) with **10 ml of the water sample**, close tightly with the cap.
2. Place the vial in the sample chamber making sure that the Σ marks are aligned.
3. Press **ZERO** key.
4. Remove the vial from the sample chamber and **empty it, leaving a few drops remaining in the vial.**
5. Add **one DPD No. 1 tablet** straight from the foil and crush the tablet using a clean stirring rod.
6. Add water sample to the 10 ml mark.
7. Close the vial tightly with the cap and swirl several times until the tablet is dissolved.
8. Place the vial in the sample chamber making sure that the Σ marks are aligned.

Zero accepted
prepare Test
press TEST

9. Press **TEST** key.

The result is shown in the display in mg/l free Chlorine.

Notes:

see page 55

1.1 Methods

1 0 0

Chlorine, total with Tablet

0.02 – 3 mg/l Cl₂



Ø 24 mm

prepare Zero
press ZERO

1. Fill a clean vial (24 mm Ø) with **10 ml of the water sample**, close tightly with the cap.
2. Place the vial in the sample chamber making sure that the Σ marks are aligned.
3. Press **ZERO** key.
4. Remove the vial from the sample chamber and **empty it, leaving a few drops remaining in the vial.**
5. Add **one DPD No. 1 tablet** and **one DPD No. 3 tablet** straight from the foil and crush the tablets using a clean stirring rod.
6. Add water sample to the 10 ml mark.
7. Close the vial tightly with the cap and swirl several times until the tablets are dissolved.
8. Place the vial in the sample chamber making sure that the Σ marks are aligned.

Zero accepted
prepare Test
press TEST

Countdown
2:00

9. Press **TEST** key.

Wait for a **reaction period of 2 minutes.**

After the reaction period is finished the measurement starts automatically.

The result is shown in the display in mg/l total Chlorine.

Notes:

see page 55

1.1 Methods



Chlorine, differentiated determination with Tablet

0.02 – 3 mg/l Cl₂



Ø 24 mm

prepare Zero
press ZERO

1. Fill a clean vial (24 mm Ø) with **10 ml of the water sample**, close tightly with the cap.
2. Place the vial in the sample chamber making sure that the Σ marks are aligned.
3. Press **ZERO** key.
4. Remove the vial from the sample chamber and **empty it, leaving a few drops remaining in the vial.**
5. Add **one DPD No. 1 tablet** straight from the foil and crush the tablet using a clean stirring rod.
6. Add water sample to the 10 ml mark.
7. Close the vial tightly with the cap and swirl several times until the tablet is dissolved.
8. Place the vial in the sample chamber making sure that the Σ marks are aligned.

Zero accepted
prepare T1
press TEST

9. Press **TEST** key.
10. Remove the vial from the sample chamber.
11. Add **one DPD No. 3 tablet** straight from the foil to the same water sample and crush the tablet using a clean stirring rod.
12. Close the vial tightly with the cap and swirl several times until the tablet is dissolved.

1.1 Methods

13. Place the vial in the sample chamber making sure that the Σ marks are aligned.

**T1 accepted
prepare T2
press TEST**

14. Press **TEST** key.

Wait for a **reaction period of 2 minutes**.

**Countdown
2:00**

After the reaction period is finished the measurement starts automatically.

The result is shown in the display in:

***,** mg/l free Cl
*,** mg/l comb Cl
*,** mg/l total Cl**

mg/l free Chlorine
mg/l combined Chlorine
mg/l total Chlorine

Notes:

see page 55

Reagent / Accessories	Form of reagent/Quantity	Order-No.
Set DPD No. 1 / No. 3	Tablet / per 100 inclusive stirring rod	517711BT
DPD No. 1	Tablet / 100	511050BT
DPD No. 3	Tablet / 100	511080BT
Set DPD No. 1 HIGH CALCIUM/ DPD No. 3 HIGH CALCIUM	Tablet / per 100 inclusive stirring rod	517781BT
DPD No. 1 HIGH CALCIUM	Tablet / 100	515740BT
DPD No. 3 HIGH CALCIUM	Tablet / 100	515730BT

1.1 Methods

1 0 4

Chlorine HR, free with Tablet

0.1 – 10 mg/l Cl₂



10 mm

prepare Zero
press ZERO

1. Fill a clean 10 mm cell with **water sample**.
2. Place the cell in the sample chamber making sure that the positioning is correct.
3. Press **ZERO** key.
4. Remove the cell from the sample chamber. Empty the cell and dry completely.
5. Rinse a beaker with the water sample and **empty it, leaving a few drops remaining in the beaker**.
6. Add **one DPD No. 1 HR tablet** straight from the foil and crush the tablet using a clean stirring rod.
7. Add **10 ml of water sample** and dissolve the tablet.
8. Fill the 10 mm cell with the coloured test solution.
9. Place the cell in the sample chamber making sure that the positioning is correct.
10. Press **TEST** key.

Zero accepted
prepare Test
press TEST

The result is shown in the display in mg/l free Chlorine.

Notes:

See page 55

1.1 Methods

1 0 4

Chlorine HR, total with Tablet

0.1 – 10 mg/l Cl₂



10 mm

prepare Zero
press ZERO

1. Fill a clean 10 mm cell with **water sample**.
2. Place the cell in the sample chamber making sure that the positioning is correct.
3. Press **ZERO** key.
4. Remove the cell from the sample chamber. Empty the cell and dry completely.
5. Rinse a beaker with the water sample and **empty it, leaving a few drops remaining in the beaker**.
6. Add **one DPD No. 1 HR and one DPD No. 3 HR tablets** straight from the foil and crush the tablet using a clean stirring rod.
7. Add **10 ml of water sample** and dissolve the tablet.
8. Fill the 10 mm cell with the coloured test solution.
9. Place the cell in the sample chamber making sure that the positioning is correct.
10. Press **TEST** key.
Wait for a **reaction period of 2 minutes**.

Zero accepted
prepare Test
press TEST

Countdown
2:00

After the reaction period is finished the measurement starts automatically.

The result is shown in the display in mg/l total Chlorine.

Notes:

See page 55

1.1 Methods

1 0 4

Chlorine HR, differentiated determination with Tablet

0.1 – 10 mg/l Cl₂



10 mm

prepare Zero
press ZERO

1. Fill a clean 10 mm cell with **water sample**.
2. Place the cell in the sample chamber making sure that the positioning is correct.
3. Press **ZERO** key.
4. Remove the cell from the sample chamber. Empty the cell and dry completely.
5. Rinse a beaker with the water sample and **empty it, leaving a few drops remaining in the beaker**.
6. Add **one DPD No. 1 HR tablet** straight from the foil and crush the tablet using a clean stirring rod.
7. Add **10 ml of water sample** and dissolve the tablet.
8. Fill the 10 mm cell with the coloured test solution.
9. Place the cell in the sample chamber making sure that the positioning is correct.

Zero accepted
prepare T1
press TEST

10. Press **TEST** key.
11. Remove the cell from the sample chamber and return the coloured test solution completely back into the beaker.

1.1 Methods

12. Add **one DPD No. 3 HR tablet** straight from the foil to the same water sample and crush the tablet using a clean stirring rod. Dissolve the tablet.

13. Fill the 10 mm cell with the coloured test solution.

14. Place the cell in the sample chamber making sure that the positioning is correct.

**T1 accepted
prepare T2
press TEST**

**Countdown
2:00**

15. Press **TEST** key.

Wait for a **reaction period of 2 minutes**.

After the reaction period is finished the measurement starts automatically.

***,** mg/l free Cl
*,** mg/l comb Cl
*,** mg/l total Cl**

The result is shown in the display in:

mg/l free Chlorine
mg/l combined Chlorine
mg/l total Chlorine

Notes:

See page 55

Reagent / Accessories	Form of reagent/Quantity	Order-No.
DPD No. 1 HR	Tablet / 100	511500BT
DPD No. 3 HR	Tablet / 100	511590BT

1.1 Methods

1 0 1

Chlorine, free with Liquid Reagent

0.02 – 3 mg/l Cl₂



prepare Zero
press ZERO

1. Fill a clean vial (24 mm Ø) with **10 ml of the water sample**, close tightly with the cap.
2. Place the vial in the sample chamber making sure that the Σ marks are aligned.
3. Press **ZERO** key.
4. Remove the vial from the sample chamber and **empty the vial**.
5. Fill the vial with drops of the same size by holding the bottle vertically and squeeze slowly:
6 drops of DPD 1 buffer solution
2 drops of DPD 1 reagent solution
6. Add water sample to the 10 ml mark.
7. Close the vial tightly with the cap and swirl several times to mix the contents.
8. Place the vial in the sample chamber making sure that the Σ marks are aligned.
9. Press **TEST** key.

Zero accepted
prepare Test
press TEST

The result is shown in the display in mg/l free Chlorine.

Notes (free and total Chlorine):

1. After use replace the bottle caps securely noting the colour coding.
2. **Store the reagent bottles in a cool, dry place ideally between 6°C and 10°C.**
3. Also see page 55 and 73.

1.1 Methods

1 0 1

Chlorine, total with Liquid Reagent

0.02 – 3 mg/l Cl₂



Ø 24 mm

prepare Zero
press ZERO

1. Fill a clean vial (24 mm Ø) with **10 ml of the water sample**, close tightly with the cap.

2. Place the vial in the sample chamber making sure that the Σ marks are aligned.

3. Press **ZERO** key.

4. Remove the vial from the sample chamber and **empty the vial**.

5. Fill the vial with drops of the same size by holding the bottle vertically and squeeze slowly:

6 drops of DPD 1 buffer solution

2 drops of DPD 1 reagent solution

3 drops of DPD 3 solution

6. Add water sample to the 10 ml mark.

7. Close the vial tightly with the cap and swirl several times to mix the contents.

8. Place the vial in the sample chamber making sure that the Σ marks are aligned.

9. Press **TEST** key.

Wait for a **reaction period of 2 minutes**.

After the reaction period is finished the measurement starts automatically.

The result is shown in the display in mg/l total Chlorine.

Zero accepted
prepare Test
press TEST

Countdown
2:00

1.1 Methods

1 0 1

Chlorine, differentiated determination with Liquid Reagent

0.02 – 3 mg/l Cl₂



prepare Zero
press ZERO

1. Fill a clean vial (24 mm Ø) with **10 ml of the water sample**, close tightly with the cap.

2. Place the vial in the sample chamber making sure that the Σ marks are aligned.

3. Press **ZERO** key.

4. Remove the vial from the sample chamber and **empty the vial**.

5. Fill the vial with drops of the same size by holding the bottle vertically and squeeze slowly:

6 drops of DPD 1 buffer solution

2 drops of DPD 1 reagent solution

6. Add water sample to the 10 ml mark.

7. Close the vial tightly with the cap and swirl several times to mix the contents.

8. Place the vial in the sample chamber making sure that the Σ marks are aligned.

9. Press **TEST** key.

10. Remove the vial from the sample chamber.

11. Add **3 drops of DPD 3 solution** to the same water sample.

12. Close the vial tightly with the cap and swirl several times to mix the contents.

Zero accepted
prepare T1
press TEST

1.1 Methods

13. Place the vial in the sample chamber making sure that the Σ marks are aligned.

T1 accepted
prepare T2
press TEST

14. Press **TEST** key.

Wait for a **reaction period of 2 minutes**.

Countdown
2:00

After the reaction period is finished the measurement starts automatically.

The result is shown in the display in:

***,** mg/l free Cl**
***,** mg/l comb. Cl**
***,** mg/l total Cl**

mg/l free Chlorine
mg/l combined Chlorine
mg/l total Chlorine

Notes:

- After use replace the bottle caps securely noting the colour coding.
- Store the reagent bottles in a cool, dry place ideally between 6°C and 10°C.**
- Also see page 55.
- In samples with high Calcium ion contents* and/or high conductivity* can lead to turbidity of the sample and therefore incorrect measurements. In this case, the reagent tablets DPD No. 1 High Calcium and DPD No. 3 High Calcium should be used as an alternative. (Order-No.: see reagents „Chlorine with Tablet“).
* *it is not possible to give exact values, because the development of turbidity depends on the nature of the sample.*

Reagent / Accessories	Form of reagent/Quantity	Order-No.
Set DPD No. 1 buffer solution DPD No. 1 reagent solution DPD No. 3 solution	(approx. 300 tests) 3 x Liquid reagent / 15 ml 1 x Liquid reagent / 15 ml 2 x Liquid reagent / 15 ml	471056
DPD No. 1 buffer solution	Liquid reagent / 15 ml	471010
DPD No. 1 reagent solution	Liquid reagent / 15 ml	471020
DPD No. 3 solution	Liquid reagent / 15 ml	471030

1.1 Methods

1 1 0

Chlorine, free with Powder Pack

0.01 – 2 mg/l Cl₂



1. Fill a clean vial (24 mm Ø) with **10 ml of the water sample**, close tightly with the cap.
2. Place the vial in the sample chamber making sure that the Σ marks are aligned.

prepare Zero
press ZERO

3. Press **ZERO** key.
4. Remove the vial from the sample chamber.

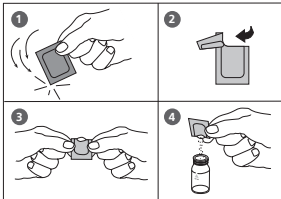

5. Add the contents of **one Chlorine FREE-DPD / F10 Powder Pack** straight from the foil to the water sample.
6. Close the vial tightly with the cap and swirl several times to mix the contents (approx. 20 seconds).
7. Place the vial in the sample chamber making sure that the Σ marks are aligned.

Zero accepted
prepare Test
press TEST

8. Press **TEST** key.

The result is shown in the display in mg/l free Chlorine.

Notes:

see page 55

1.1 Methods

1 1 0

Chlorine, total with Powder Pack

0.01 – 2 mg/l Cl₂



prepare Zero
press ZERO

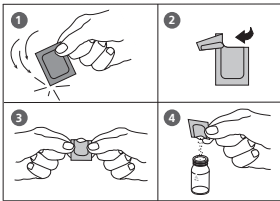

Zero accepted
prepare Test
press TEST

Countdown
3:00

1. Fill a clean vial (24 mm Ø) with **10 ml of the water sample**, close tightly with the cap.
2. Place the vial in the sample chamber making sure that the ∇ marks are aligned.

3. Press **ZERO** key.

4. Remove the vial from the sample chamber.

5. Add the contents of **one Chlorine TOTAL-DPD / F10 Powder Pack** straight from the foil to the water sample.

6. Close the vial tightly with the cap and swirl several time to mix the contents (approx. 20 seconds).

7. Place the vial in the sample chamber making sure that the ∇ marks are aligned.

8. Press **TEST** key.

Wait for a **reaction period of 3 minutes**.

After the reaction period is finished the measurement starts automatically.

The result is shown in the display in mg/l total Chlorine.

Notes:

see page 55

1.1 Methods

1 1 0

Chlorine, differentiated determination with Powder Pack

0.01 – 2 mg/l Cl₂

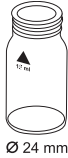

1. Fill a clean vial (24 mm Ø) with **10 ml of the water sample**, close tightly with the cap.
2. Place the vial in the sample chamber making sure that the Σ marks are aligned.

prepare Zero
press ZERO

3. Press **ZERO** key.
4. Remove the vial from the sample chamber.

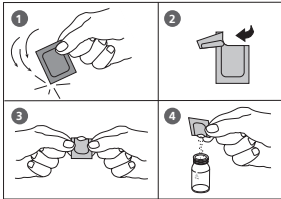

5. Add the contents of **one Chlorine FREE-DPD / F10 Powder Pack** straight from the foil to the water sample.
6. Close the vial tightly with the cap and swirl several times to mix the contents (approx. 20 seconds).
7. Place the vial in the sample chamber making sure that the Σ marks are aligned.

Zero accepted
prepare T1
press TEST

8. Press **TEST** key.
9. Remove the vial from the sample chamber, empty the vial, rinse vial and cap several times and then fill the vial with **10 ml of water sample**.
10. Add the contents of **one Chlorine TOTAL-DPD / F10 Powder Pack** straight from the foil to the water sample.
11. Close the vial tightly with the cap and swirl several times to mix the contents (approx. 20 seconds).

1.1 Methods

T1 accepted
prepare T2
press TEST

Countdown
3:00

*,** mg/l free Cl
*,** mg/l comb. Cl
*,** mg/l total Cl

12. Place the vial in the sample chamber making sure that the Σ marks are aligned.

13. Press **TEST** key.

Wait for a **reaction period of 3 minutes**.

After the reaction period is finished the measurement starts automatically.

The result is shown in the display in:

mg/l free Chlorine
mg/l combined Chlorine
mg/l total Chlorine

Notes:

see page 55

Reagent / Accessories	Form of reagent/Quantity	Order-No.
Chlorine Free-DPD/F10	Powder Pack / 100	530100
Chlorine Total-DPD/F10	Powder Pack / 100	530120

1.1 Methods



Chlorine MR, free with Vario Powder Pack

0.01 – 3.5 mg/l Cl₂





Ø 24 mm

1. Fill a clean vial (24 mm Ø) with **10 ml of the water sample**, close tightly with the cap.
2. Place the vial in the sample chamber making sure that the Σ marks are aligned.

prepare Zero
press ZERO

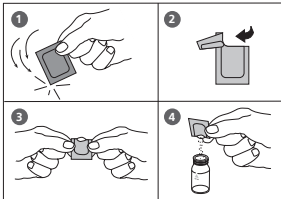
3. Press **ZERO** key.
4. Remove the vial from the sample chamber.



5. Add the contents of **one Vario Chlorine FREE-DPD / F10 Powder Pack (blue color marking **) straight from the foil to the water sample.
6. Close the vial tightly with the cap and swirl several times to mix the contents (approx. 20 seconds).
7. Place the vial in the sample chamber making sure that the Σ marks are aligned.

Zero accepted
prepare Test
press TEST

8. Press **TEST** key.

The result is shown in the display in mg/l free Chlorine.

Notes:

see page 55

1.1 Methods

1 1 3

Chlorine MR, total with Vario Powder Pack

0.01 – 3.5 mg/l Cl₂



1. Fill a clean vial (24 mm Ø) with **10 ml of the water sample**, close tightly with the cap.
2. Place the vial in the sample chamber making sure that the ∇ marks are aligned.

prepare Zero
press ZERO

3. Press **ZERO** key.
4. Remove the vial from the sample chamber.

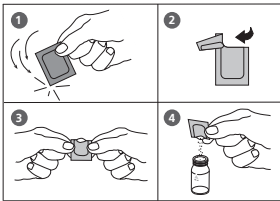

5. Add the contents of **one Vario Chlorine TOTAL-DPD / F10 Powder Pack (blue color marking \equiv)** straight from the foil to the water sample.
6. Close the vial tightly with the cap and swirl several time to mix the contents (approx. 20 seconds).
7. Place the vial in the sample chamber making sure that the ∇ marks are aligned.

Zero accepted
prepare Test
press TEST

8. Press **TEST** key.

Countdown
3:00

Wait for a **reaction period of 3 minutes**.

After the reaction period is finished the measurement starts automatically.

The result is shown in the display in mg/l total Chlorine.

Notes:

see page 55

1.1 Methods

1 1 3

Chlorine MR, differentiated determination with Vario Powder Pack

0.01 – 3.5 mg/l Cl₂



Ø 24 mm

prepare Zero
press ZERO

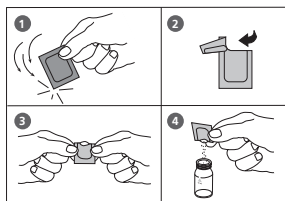

1. Fill a clean vial (24 mm Ø) with **10 ml of the water sample**, close tightly with the cap.
2. Place the vial in the sample chamber making sure that the Σ marks are aligned.
3. Press **ZERO** key.
4. Remove the vial from the sample chamber.

5. Add the contents of **one Vario Chlorine FREE-DPD / F10 Powder Pack (blue color marking **) straight from the foil to the water sample.
6. Close the vial tightly with the cap and swirl several times to mix the contents (approx. 20 seconds).
7. Place the vial in the sample chamber making sure that the Σ marks are aligned.

Zero accepted
prepare T1
press TEST

8. Press **TEST** key.
9. Remove the vial from the sample chamber, empty the vial, rinse vial and cap several times and then fill the vial with **10 ml of water sample**.
10. Add the contents of **one Vario Chlorine TOTAL-DPD / F10 Powder Pack (blue color marking **) straight from the foil to the water sample.
11. Close the vial tightly with the cap and swirl several times to mix the contents (approx. 20 seconds).

1.1 Methods

**T1 accepted
prepare T2
press TEST**

**Countdown
3:00**

***,** mg/l free Cl
*,** mg/l comb. Cl
*,** mg/l total Cl**

12. Place the vial in the sample chamber making sure that the Σ marks are aligned.

13. Press **TEST** key.

Wait for a **reaction period of 3 minutes**.



After the reaction period is finished the measurement starts automatically.

The result is shown in the display in:

mg/l free Chlorine
mg/l combined Chlorine
mg/l total Chlorine

Notes:

see page 55

Reagent / Accessories		Form of reagent/Quantity	Order-No.
VARIO Chlorine Free-DPD/F10 (blue color marking)		Powder Pack / 100	530180
VARIO Chlorine Total-DPD/F10 (blue color marking)		Powder Pack / 100	530190

1.1 Methods



1 0 5

Chlorine HR (KI) with Tablet

5 – 200 mg/l Cl₂



prepare Zero
press ZERO

1. Fill a clean vial (16 mm Ø) with **8 ml of the water sample**, close tightly with the cap.
2. Place the vial in the sample chamber making sure that the marks  are aligned.
3. Press **ZERO** key.
4. Remove the vial from the sample chamber.
5. Add **one CHLORINE HR (KI) tablet** straight from the foil to the water sample and crush the tablet using a clean stirring rod.
6. Add **one ACIDIFYING GP tablet** straight from the foil to the same water sample and crush the tablet using a clean stirring rod.
7. Close the vial tightly with the cap and swirl several times until the tablets are dissolved.
8. Place the vial in the sample chamber making sure that the marks  are aligned.
9. Press **TEST** key.

Zero accepted
prepare Test
press TEST

The result is shown in the display in mg/l Chlorine.

1.1 Methods

Notes:

1. Oxidizing agents interfere as they react in the same way as Chlorine.

Reagent / Accessories	Form of reagent/Quantity	Order-No.
Set: ACIDIFYING GP/ CHLORINE HR (KI)	Tablet / per 100 inclusive stirring rod	517721BT
CHLORINE HR (KI)	Tablet / 100	513000BT
ACIDIFYING GP	Tablet / 100	515480BT

1.1 Methods

1

1

9

Chlorine dioxide in absence of Chlorine with Tablet

0.05 – 1 mg/l ClO₂

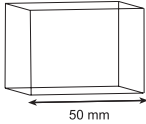

prepare Zero
press ZERO

1. Fill a clean 50 mm cell with **water sample**.
2. Place the cell in the sample chamber making sure that the positioning is correct.
3. Press **ZERO** key.
4. Remove the cell from the sample chamber. Empty the cell and dry completely.
5. Rinse a beaker with the sample and **empty it, leaving a few drops remaining in the beaker**.
6. Add **one DPD No. 1 tablet** straight from the foil and crush the tablet using a clean stirring rod.
7. Add **10 ml of water sample** and dissolve the tablet.
8. Fill the 50 mm cell with the coloured test solution.
9. Place the cell in the sample chamber making sure that the positioning is correct.
10. Press **TEST** key.

Zero accepted
prepare Test
press TEST

The result is shown in the display in mg/l Chlorine dioxide.

1.1 Methods

Notes:

1. Vial cleaning:

As many household cleaners (e.g. dishwasher detergent) contain reducing substances, the subsequent determination of Oxidizing agents (e.g. Chlorine, Bromine) may show lower results. To avoid any measurement errors, only use glassware free of Chlorine demand.

Preparation: Put all applicable glassware into Sodium hypochlorite solution (0.1 g/l) for one hour, then rinse all glassware thoroughly with deionised water.

2. Preparing the sample:

When preparing the sample, the lost of Chlorine dioxide, e.g. by pipetting or shaking, must be avoided. The analysis must take place immediately after taking the sample.

3. The DPD colour development is carried out at a pH value of 6.2 to 6.5. The reagent tablet therefore contains a buffer for the pH adjustment.

Strong alkaline or acidic water samples must be adjusted between pH 6 and pH 7 before the tablet is added (use 0.5 mol/l Sulfuric acid resp. 1 mol/l Sodium hydroxide).

4. Turbidity (can lead to errors):

The use of the DPD No. 1 tablet in samples with high Calcium ion contents* and/or high conductivity* can lead to turbidity of the sample and therefore incorrect measurements. In this case, the reagent tablet DPD No. 1 High Calcium should be used as an alternative.
** it is not possible to give exact values, because the development of turbidity depends on the nature of the sample.*

5. Exceeding the measuring range:

Concentrations above 19 mg/l Chlorine dioxide can lead to results showing 0 mg/l.

In this case, the water sample must be diluted with water free of Chlorine dioxide.

10 ml of the diluted sample should be mixed with the reagent and the measurement repeated.

6. Oxidising agents such as Chlorine, Ozone etc. interfere as they react in the same way as Chlorine dioxide.

Reagent / Accessories	Form of reagent/Quantity	Order-No.
DPD No. 1	Tablet / 100	511050BT

1.1 Methods

1

2

0

Chlorine dioxide with Tablet

0.05 – 2.5 mg/l ClO₂

Chlorine dioxide
>> **with Cl**
without Cl

The following selection is shown in the display:

>> **with Cl**

for the determination of Chlorine dioxide in the presence of Chlorine.

>> **without Cl**

for the determination of Chlorine dioxide in the absence of Chlorine.

Select the desired determination with the arrow keys [▲] and [▼]. Confirm with [↵] key.

1.1 Methods

Notes:

1. Vial cleaning:
As many household cleaners (e.g. dishwasher detergent) contain reducing substances, the subsequent determination of Chlorine dioxide may show lower results. To avoid any measurement errors, only use glassware free of Chlorine demand.
Preparation: Put all applicable glassware into Sodium hypochlorite solution (0.1 g/l) for one hour, then rinse all glassware thoroughly with deionised water.
2. Preparing the sample:
When preparing the sample, the loss of Chlorine dioxide, e.g. by pipetting or shaking, must be avoided. The analysis must take place immediately after taking the sample.
3. The DPD colour development is carried out at a pH value of 6.2 to 6.5. The reagent tablet therefore contains a buffer for the pH adjustment.
Strong alkaline or acidic water samples must be adjusted between pH 6 and pH 7 before the tablet is added (use 0.5 mol/l Sulfuric acid resp. 1 mol/l Sodium hydroxide).
4. Exceeding the measuring range:
Concentrations above 19 mg/l Chlorine dioxide can lead to results showing 0 mg/l. In this case, the water sample must be diluted with water free of Chlorine dioxide. 10 ml of the diluted sample should be mixed with the reagent and the measurement repeated.
5. If ??? is displayed at a differentiated test result see page 356.
6. Oxidising agents such as Chlorine, Ozone etc. interfere as they react in the same way as Chlorine dioxide.

Reagent / Accessories	Form of reagent/Quantity	Order-No.
DPD No. 1	Tablet / 100	511050BT
GLYCINE	Tablet / 100	512170BT

1.1 Methods



Chlorine dioxide in the presence of Chlorine with Tablet

0.05 – 2.5 mg/l ClO₂



1. Fill a clean vial (24 mm Ø) with **10 ml of the water sample**.
2. Add **one GLYCINE tablet** straight from the foil and crush the tablet using a clean stirring rod.
3. Close the vial tightly with the cap and swirl several times until the tablet is dissolved.
4. **Fill a second clean vial with 10 ml of water sample** and close tightly with the cap.
5. Place the vial in the sample chamber making sure that the Σ marks are aligned.
6. Press **ZERO** key.
7. Remove the vial from the sample chamber and **empty the vial**.
8. Add **one DPD No. 1 tablet** straight from the foil and crush the tablet using a clean stirring rod.
9. **Transfer the contents of the first vial (Glycine solution) into the prepared vial (point 8)**.
10. Close the vial tightly with the cap and swirl several times until the tablet is dissolved.
11. Place the vial in the sample chamber making sure that the Σ marks are aligned.
12. Press **TEST** key.

prepare Zero
press ZERO

Zero accepted
prepare T1
press TEST

1.1 Methods

**T1 accepted
prepare T2
press TEST**

13. Remove the vial from the sample chamber, empty the vial, rinse vial and cap several times. Fill with **a few drops of water sample**.
14. Add **one DPD No. 1 tablet** straight from the foil and crush the tablet using a clean stirring rod.
15. Add water sample to the 10 ml mark.
16. Close the vial tightly with the cap and swirl several times until the tablet is dissolved.
17. Place the vial in the sample chamber making sure that the Σ marks are aligned.
18. Press **TEST** key.
19. Remove the vial from the sample chamber.
20. Add **one DPD No. 3 tablet** straight from the foil to the same water sample and crush the tablet using a clean stirring rod.
21. Close the vial tightly with the cap and swirl several times until the tablet is dissolved.
22. Place the vial in the sample chamber making sure that the Σ marks are aligned.
23. Press **TEST** key.
Wait for a **reaction period of 2 minutes**.

**T2 accepted
prepare T3
press TEST**

**Countdown
2:00**

After the reaction period is finished the measurement starts automatically.

***,** mg/l ClO₂ [Cl]**

The result is shown in the display in:
as Chlorine dioxide in mg/l Chlorine,
or
as Chlorine dioxide in mg/l ClO₂.

***,** mg/l ClO₂**

***,** mg/l free Cl
*,** mg/l comb. Cl
*,** mg/l total Cl**

mg/l free Chlorine
mg/l combined Chlorine
mg/l total Chlorine

Notes:

See next page.

1.1 Methods

Notes:

(Chlorine dioxide in the presence of Chlorine)

1. The conversion factor to convert Chlorine dioxide as Chlorine to Chlorine dioxide as ClO_2 is approximately 0.4 (more exactly 0.38).

$$\text{mg/l ClO}_2 = \text{mg/l ClO}_2 [\text{Cl}] \times 0.38$$



(Chlorine dioxide displayed as Chlorine units $\text{ClO}_2 [\text{Cl}]$ has its origin in swimming poolwater treatment according to DIN 19643.)

2. The total Chlorine result given includes the contribution of the Chlorine dioxide (as Chlorine) reading. For true total Chlorine value subtract the Chlorine dioxide (as Chlorine) reading from the quoted total Chlorine reading.

3. Also see page 87.

Reagent / Accessories	Form of reagent/Quantity	Order-No.
DPD No. 1	Tablet / 100	511050BT
GLYCINE	Tablet / 100	512170BT

1.1 Methods



Chlorine dioxide in absence of Chlorine with Tablet

0.05 – 2.5 mg/l ClO₂



Ø 24 mm

**prepare Zero
press ZERO**

1. Fill a clean vial (24 mm Ø) with **10 ml of the water sample**, close tightly with the cap.
2. Place the vial in the sample chamber making sure that the ∇ marks are aligned.
3. Press **ZERO** key.
4. Remove the vial from the sample chamber and **empty it, leaving a few drops remaining in the vial.**
5. Add **one DPD No. 1 tablet** straight from the foil and crush the tablet using a clean stirring rod.
6. Add water sample to the 10 ml mark.
7. Close the vial tightly with the cap and swirl several times until the tablet is dissolved.
8. Place the vial in the sample chamber making sure that the ∇ marks are aligned.

**Zero accepted
prepare Test
press TEST**

9. Press **TEST** key.

The result is shown in the display

as Chlorine dioxide in mg/l Chlorine,
or
as Chlorine dioxide in mg/l ClO₂.

***,** mg/l ClO₂ [Cl]**

***,** mg/l ClO₂**

Notes:

see page 87

1.1 Methods

1

2

4

Chromium with Powder Pack

0.005 – 0.5 mg/l Cr / 5 – 500 µg/l Cr

1

2

5

Chromium with Powder Pack

0.02 – 2 mg/l Cr

Chrom

>>

diff
Cr (VI)
Cr (III + VI)

The following selection is shown in the display:

>>

diff

for the differentiated determination of Chromium (VI), Chromium (III) and total Chromium

>>

Cr (VI)

for the determination of Chromium (VI)

>>

Cr (III + VI)

for the determination of total Chromium (sum Cr (III) + Cr (VI))

Select the desired determination with the arrow keys **[▲]** and **[▼]**. Confirm with the **[↵]** key.

1.1 Methods

1

2

4

Chromium, differentiated determination with Powder Pack

0.005 – 0.5 mg/l Cr / 5 – 500 µg/l Cr



Digestion:

1. Fill **10 ml of water sample** into a clean vial (16 mm Ø).
2. Add the contents of **one PERSULFRGT FOR CR Powder Pack** straight from the foil into the vial.
3. Close the vial tightly with the cap and swirl several times to mix the contents.
4. Heat the vial for **120 minutes** in a preheated thermo-reactor at a temperature of **100°C**.
5. Remove the vial from the thermoreactor.
(CAUTION: The vials are hot!).
Invert the vial and allow to cool to room temperature.

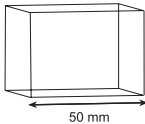

Performing test procedure:

6. Fill a clean 50 mm cell with **deionised water**.
7. Place the cell in the sample chamber making sure that the positioning is correct.
8. Press **ZERO** key.
9. Remove the cell from the sample chamber. Empty the cell and dry completely.
10. Add the contents of **one CHROMIUM HEXAVALENT** from the foil into the pre prepared vial (see step 5).
11. Close the vial tightly with the cap and swirl several times to mix the contents.
12. Fill the 50 mm cell with this test solution.
13. Place the cell in the sample chamber making sure that the positioning is correct.
14. Press **TEST** key.

Wait for a **reaction period of 5 minutes**.

After the reaction period is finished the measurement starts automatically.

prepare Zero
press ZERO

Zero accepted
prepare T1
press TEST

Countdown
5:00

1.1 Methods



**T1 accepted
prepare T2
press TEST**

**Countdown
5:00**

***,** mg/l Cr (VI)
*,** mg/l Cr (III)
*,** mg/l Cr tot.**

15. Fill a second clean vial (16 mm Ø) with **10 ml of the water sample**.
16. Add the contents of **one CHROMIUM HEXAVALENT Powder Pack** straight from the foil to the water sample.
17. Close the vial tightly with the cap and swirl several times to mix the contents.
18. Fill the 50 mm cell with this test solution.
19. Place the cell in the sample chamber making sure that the positioning is correct.
20. Press **TEST** key.

Wait for a **reaction period of 5 minutes**.

After the reaction period is finished the measurement starts automatically.

The result is shown in the display in:

mg/l Cr (VI)
mg/l Cr (III)
mg/l Cr total chromium

Notes:

1. Performing steps 1–14 determines concentration of total chromium and steps 15–20 determines concentration of Chromium (VI). The concentration of Chromium (III) results out of the difference.
2. pH value of the water sample should be between 3 and 9.
3. For information about interferences especially in waste water and chemical waste water through metals and reductive or oxidic agents see DIN 38 405 – D 24 and Standard Methods of Water and Wastewater, 20th Edition; 1998.

▲ mg/l
▼ µg/l

Reagent / Accessories	Form of reagent/Quantity	Order-No.
PERSULF.RGT FOR CR	Powder Pack / 100	537300
CHROMIUM HEXAVALENT	Powder Pack / 100	537310

1.1 Methods

1 2 4

Chromium (VI) with Powder Pack

0.005 – 0.5 mg/l Cr / 5 – 500 µg/l Cr

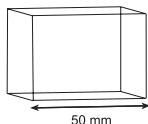

prepare Zero
press ZERO



Zero accepted
prepare Test
press TEST

Countdown
5:00

1. Fill a clean 50 mm cell with **deionised water**.
2. Place the cell in the sample chamber making sure that the positioning is correct.
3. Press **ZERO** key.
4. Remove the cell from the sample chamber. Empty the cell and dry completely.
5. Fill **10 ml of water sample** into a clean vial (16 mm Ø).
6. Add the contents of **one CHROMIUM HEXAVALENT Powder Pack** straight from the foil to the water sample.
7. Close the vial tightly with the cap and swirl several times to mix the contents.
8. Fill the 50 mm cell with this test solution.
9. Place the cell in the sample chamber making sure that the positioning is correct.
10. Press **TEST** key.

Wait for a **reaction period of 5 minutes**.

After the reaction period is finished the measurement starts automatically.

The result is shown in the display as Chromium (VI).

Notes: see previous page

Reagent / Accessories	Form of reagent/Quantity	Order-No.
PERSULF.RGT FOR CR	Powder Pack / 100	537300
CHROMIUM HEXAVALENT	Powder Pack / 100	537310

1.1 Methods



Chromium, total (Cr(III) + Cr(VI)) with Powder Pack

0.005 – 0.5 mg/l Cr / 5 – 500 µg/l Cr



Ø 16 mm

Digestion:

1. Fill a clean vial (16 mm Ø) with **10 ml of water sample**.
2. Add the contents of **one PERSULF.RGT FOR CR Powder Pack** straight from the foil into the vial.
3. Close the vial tightly with the cap and swirl several times to mix the contents.
4. Heat the vial for **120 minutes** in a preheated thermo-reactor at a temperature of **100°C**.
5. Remove the vial from the thermoreactor.
(CAUTION: The vials are hot!).
Invert the vial and allow to cool to room temperature.

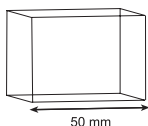

50 mm

Performing test procedure:

6. Fill a clean 50 mm cell with **deionised water**.
7. Place the cell in the sample chamber making sure that the positioning is correct.
8. Press **ZERO** key.
9. Remove the cell from the sample chamber. Empty the cell and dry completely.
10. Add the contents of **one CHROMIUM HEXAVALENT Powder Pack** straight from the foil to the pre-prepared water sample.
11. Close the vial tightly with the cap and swirl several times to mix the contents.
12. Fill the 50 mm cell with this test solution.
13. Place the cell in the sample chamber making sure that the positioning is correct.
14. Press **TEST** key.

Wait for a **reaction period of 5 minutes**.

After the reaction period is finished the measurement starts automatically.

The result is shown in the display as total Chromium.

prepare Zero
press ZERO

Zero accepted
prepare Test
press TEST

Countdown
5:00

1.1 Methods

1

2

5

Chromium, differentiated determination with Powder Pack

0.02 – 2 mg/l Cr





Ø 16 mm

Digestion:

1. Fill a clean vial (16 mm Ø) with **10 ml of water sample**.
2. Add the contents of **one PERSULFURGT FOR CR Powder Pack** straight from the foil into the vial.
3. Close the vial tightly with the cap and swirl several times to mix the contents.
4. Heat the vial for **120 minutes** in a preheated thermoreactor at a temperature of **100°C**.
5. Remove the vial from the thermoreactor.
(CAUTION: The vials are hot!).
Invert the vial and allow to cool to room temperature.

Performing test procedure:

6. Place the pre prepared vial in the sample chamber making sure that the marks  are aligned.
7. Press **ZERO** key.
8. Remove the vial from the sample chamber.
9. Add the contents of **one CHROMIUM HEXAVALENT Powder Pack** straight from the foil into the pre prepared vial.
10. Close the vial tightly with the cap and swirl several times to mix the contents.
11. Place the vial in the sample chamber making sure that the marks  are aligned.
12. Press **TEST** key.

Wait for a **reaction period of 5 minutes**.

After the reaction period is finished the measurement starts automatically.

prepare Zero
press ZERO

Zero accepted
prepare T1
press TEST

Countdown
5:00

1.1 Methods



**T1 accepted
prepare T2
press TEST**

**Countdown
5:00**

***,** mg/l Cr (VI)
*,** mg/l Cr (III)
*,** mg/l Cr tot.**

13. Fill a second clean vial (16 mm Ø) with **10 ml of the water sample**.
14. Add the contents of **one CHROMIUM HEXAVALENT Powder Pack** straight from the foil to the water sample.
15. Close the vial tightly with the cap and swirl several times to mix the contents.
16. Place the vial in the sample chamber making sure that the marks are aligned.
17. Press **TEST** key.

Wait for a **reaction period of 5 minutes**.

After the reaction period is finished the measurement starts automatically.

The result is shown in the display in:

mg/l Cr (VI)
mg/l Cr (III)
mg/l Cr total Chromium

Notes:

1. Performing steps 1–12 determines concentration of total chromium and steps 13–17 determines concentration of Chromium (VI). The concentration of Chromium (III) results out of the difference.
2. pH value of the water sample should be between 3 and 9.
3. For information about interferences especially in waste water and chemical waste water through metals and reductive or oxidic agents see DIN 38 405 – D 24 and Standard Methods of Water and Wastewater, 20th Edition; 1998.

Reagent / Accessories	Form of reagent/Quantity	Order-No.
PERSULF.RGT FOR CR	Powder Pack / 100	537300
CHROMIUM HEXAVALENT	Powder Pack / 100	537310

1.1 Methods

1

2

5



Chromium (VI) with Powder Pack

0.02 – 2 mg/l Cr



Ø 16 mm

prepare Zero
press ZERO

1. Fill a clean vial (16 mm Ø) with **10 ml of the water sample**.
2. Place the vial in the sample chamber making sure that the marks  are aligned.
3. Press **ZERO** key.
4. Remove the vial from the sample chamber.
5. Add the contents of **one CHROMIUM HEXAVALENT Powder Pack** straight from the foil to the water sample.
6. Close the vial tightly with the cap and swirl several times to mix the contents.
7. Place the vial in the sample chamber making sure that the marks  are aligned.
8. Press **TEST** key.

Zero accepted
prepare Test
press TEST

Countdown
5:00

Wait for a **reaction period of 5 minutes**.

After the reaction period is finished the measurement starts automatically.

The result is shown in the display in mg/l Chromium (VI).

Notes: see previous page

Reagent / Accessories	Form of reagent/Quantity	Order-No.
PERSULF.RGT FOR CR	Powder Pack / 100	537300
CHROMIUM HEXAVALENT	Powder Pack / 100	537310

1.1 Methods



Chromium, total (Cr(III) + Cr(VI)) with Powder Pack

0.2 – 2 mg/l Cr



Ø 16 mm

Digestion:

1. Fill a clean vial (16 mm Ø) with **10 ml of water sample**.
2. Add the contents of **one PERSULF.RGT FOR CR Powder Pack** straight from the foil into the vial.
3. Close the vial tightly with the cap and swirl several times to mix the contents.
4. Heat the vial for **120 minutes** in a preheated thermo-reactor at a temperature of **100 °C**.
5. Remove the vial from the thermoreactor.
(CAUTION: The vials are hot!).
Invert the vial and allow to cool to room temperature.

Performing test procedure:

6. Place the pre prepared vial in the sample chamber making sure that the marks Δ are aligned.
7. Press **ZERO** key.
8. Remove the vial from the sample chamber.
9. Add the contents of **one CHROMIUM HEXAVALENT Powder Pack** straight from the foil to the water sample.
10. Close the vial tightly with the cap and swirl several times to mix the contents.
11. Place the vial in the sample chamber making sure that the marks Δ are aligned.
12. Press **TEST** key.

Wait for a **reaction period of 5 minutes**.

After the reaction period is finished the measurement starts automatically.

The result is shown in the display in mg/l total Chromium.

prepare Zero
press ZERO

Zero accepted
prepare Test
press TEST

Countdown
5:00

1.1 Methods

1

3

0

COD LR with Vario Tube Test

3 – 150 mg/l O₂



Ø 16 mm

1. Open one white capped reaction vial and add **2 ml deionised water** (this is the blank (Note 1)).
2. Open another white capped reaction vial and add **2 ml of water sample** (this is the sample).
3. Close the vials tightly with the cap. Invert the vial gently several times to mix the contents.
(CAUTION: The vial will become hot during mixing!)
4. Heat the vials for **120 minutes** in the preheated reactor at a temperature of **150°C**.
5. **(CAUTION: The vials are hot!)**
Remove the tubes from the heating block and allow them to cool to 60°C or less. Mix the contents by carefully inverting each tube several times while still warm. Then allow the tubes to cool to ambient temperature before measuring. (Note 2).
6. Place the vial (the blank (Note 3, 4)) in the sample chamber making sure that the marks Δ are aligned.
7. Press **ZERO** key.
8. Remove the vial from the sample chamber.
9. Place the vial (the sample (Note 3, 4)) in the sample chamber making sure that the marks Δ are aligned.
10. Press **TEST** key.

prepare Zero
press ZERO

Zero accepted
prepare Test
press TEST

The result is shown in the display in mg/l COD.

1.1 Methods

Notes:

1. Run samples and blanks with the same batch of vials. The blank is stable when stored in the dark and can be used for further measurements with vials of the same batch.
2. Do not place the hot vials in the sample chamber. Cool the vials to room temperature for final measurements.
3. Suspended solids in the vial lead to incorrect measurements. For this reason it is important to place the vials carefully in the sample chamber. The precipitate at the bottom of the sample should be not suspended.
4. Clean the outside of the vials with a towel. Finger prints or other marks will be removed.
5. Samples can be measured when the Chloride content does not exceed 1000 mg/l.
6. In exceptional cases, compounds contained in the water cannot be oxidized adequately, so results may be lower than reference methods.

Reagent / Accessories	Form of reagent/Quantity	Order-No.
CSB VARIO LR 3 - 150 mg/l	1 Set (25 tests)	2420720

1.1 Methods

1

3

1

COD MR with Vario Tube Test

20 – 1 500 mg/l O₂



Ø 16 mm

1. Open one white capped reaction vial and add **2 ml deionised water** (this is the blank (Note 1)).
2. Open another white capped reaction vial and add **2 ml water sample** (this is the sample).
3. Close the vials tightly with the cap. Invert the vial gently several times to mix the contents.
(CAUTION: The vial will become hot during mixing!)
4. Heat the vials for **120 minutes** in the preheated reactor at a temperature of **150°C**.
5. **(CAUTION: The vials are hot!)**
Remove the tubes from the heating block and allow them to cool to 60°C or less. Mix the contents by carefully inverting each tube several times while still warm. Then allow the tubes to cool to ambient temperature before measuring. (Note 2).
6. Place the vial (the blank (Note 3, 4)) in the sample chamber making sure that the marks Δ are aligned.
7. Press **ZERO** key.
8. Remove the vial from the sample chamber.
9. Place the vial (the sample (Note 3, 4)) in the sample chamber making sure that the marks Δ are aligned.
10. Press **TEST** key.

prepare Zero
press ZERO

Zero accepted
prepare Test
press TEST

The result is shown in the display in mg/l COD.

1.1 Methods

Notes:

1. Run samples and blanks with the same batch of vials. The blank is stable when stored in the dark and can be used for further measurements with vials of the same batch.
2. Do not place the hot vials in the sample chamber. Cool the vials to room temperature for final measurements.
3. Suspended solids in the vial lead to incorrect measurements. For this reason it is important to place the vials carefully in the sample chamber. The precipitate at the bottom of the sample should be not suspended.
4. Clean the outside of the vials with a towel. Finger prints or other marks will be removed.
5. Samples can be measured when the Chloride content does not exceed 1000 mg/l.
6. In exceptional cases, compounds contained in the water cannot be oxidized adequate, so results may be lower than reference methods.
7. For samples under 100 mg/l COD it is recommended to repeat the test with the tube test for COD LR.

Reagent / Accessories	Form of reagent/Quantity	Order-No.
CSB VARIO MR 20 - 1500 mg/l	1 Set (25 tests)	2420721

1.1 Methods

1

3

2

COD HR with Vario Tube Test

0.2 – 15 g/l O₂ (≙ 200 – 15 000 mg/l O₂)



Ø 16 mm

1. Open one white capped reaction vial and add **0.2 ml deionised water** (this is the blank (Note 1)).
2. Open another white capped reaction vial and add **0.2 ml water sample** (this is the sample).
3. Close the vials tightly with the cap. Invert the vial gently several times to mix the contents.
(CAUTION: The vial will become hot during mixing!)
4. Heat the vials for **120 minutes** in the preheated reactor at a temperature of **150°C**.
5. **(CAUTION: The vials are hot!)**
Remove the tubes from the heating block and allow them to cool to 60°C or less. Mix the contents by carefully inverting each tube several times while still warm. Then allow the tubes to cool to ambient temperature before measuring. (Note 2).
6. Place the vial (the blank (Note 3, 4)) in the sample chamber making sure that the marks Δ are aligned.
7. Press **ZERO** key.
8. Remove the vial from the sample chamber.
9. Place the vial (the sample (Note 3, 4)) in the sample chamber making sure that the marks Δ are aligned.
10. Press **TEST** key.

prepare Zero
press ZERO

Zero accepted
prepare Test
press TEST

The result is shown in the display in **g/l** COD.

1.1 Methods

Notes:

1. Run samples and blanks with the same batch of vials. The blank is stable when stored in the dark and can be used for further measurements with vials of the same batch.
2. Do not place the hot vials in the sample chamber. Cool the vials to room temperature for final measurements.
3. Suspended solids in the vial lead to incorrect measurements. For this reason it is important to place the vials carefully in the sample chamber. The precipitate at the bottom of the sample should be not suspended.
4. Clean the outside of the vials with a towel. Finger prints or other marks will be removed.
5. Samples can be measured when the Chloride content does not exceed 10 000 mg/l.
6. In exceptional cases, compounds contained in the water cannot be oxidized adequate, so results may be lower than reference methods.
7. For samples under 1 g/l COD it is recommended to repeat the test with the test kit for COD MR or for samples under 0.1 g/l COD with the tube test COD LR.

Reagent / Accessories	Form of reagent/Quantity	Order-No.
CSB VARIO HR 200 - 15000 mg/l	1 Set (25 tests)	2420722

1.1 Methods



Colour, true and apparent (APHA Platinum-Cobalt Standard Method)

0 – 500 Pt-Co units

Sample preparation (Note 4):

Step A

Filter approx. **50 ml deionised water** through a membrane filter with a pore width of 0.45 µm. Discard the filtrate. Filter another **50 ml deionised water** and keep it for zeroing.

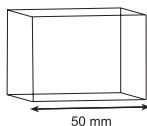

Step B

Filter approx. **50 ml water sample** using the same filter. Keep this filtrate for sample measurement.

prepare Zero
press ZERO

1. Fill a clean 50 mm cell with **deionised water** (from Step A).
2. Place the cell in the sample chamber making sure that the positioning is correct.
3. Press **ZERO** key.
4. Remove the vial from the sample chamber and empty it completely.
5. Use some of the filtered water sample to rinse out the cell, then fill the sample into the cell. (from Step B).
6. Place the cell in the sample chamber making sure that the positioning is correct.
7. Press **TEST** key.

Zero accepted
prepare Test
press TEST

The result is shown in the display in Pt-Co units (mg/l Pt).

1.1 Methods

Notes:

1. This colour scale was originally developed by A. Hazen as a visual comparison scale. It is therefore necessary to ascertain whether the extinction maximum of the water sample is in the range from 420 to 470 nm, as this method is only suitable for water samples with yellowish to yellowish-brown coloration. Where applicable, a decision should be made based on visual inspection of the water sample.
2. This method is calibrated on the basis of the standards specified by "Standard Methods for the Examination of Water and Wastewater" (also see EN ISO 7887:1994).
1 Pt-Co colour unit $\hat{=}$ 1 mg/L of platinum as chloroplatinate ion
3. The estimated detection limit is 10 mg/L Pt.
4. Colour may be expressed as "apparent" or "true" colour. The apparent colour is defined as the colour of a solution due to dissolved substances and suspended particles in the sample. This manual describes the determination of true colour by filtration of the water sample. To determine the apparent colour, non-filtrated deionised water and sample are measured.
5. Sample collection, preservation and storage:
Pour the water sample into clean glass or plastic containers and analyse as soon as possible after the sample is taken. If this is not possible, fill the container right up to the top and seal tightly. Do not stir the sample; avoid lengthy contact with the air. The sample may be stored in a dark place at a temperature of 4°C for 24 hours. Before performing measurements, the water sample must be brought up to room temperature.

1.1 Methods

1 4 9

Copper with Tablet

0.05 – 1 mg/l Cu

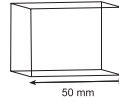

1 5 0

Copper with Tablet

0.5 – 5 mg/l Cu



Copper

>> diff
free
total

The following selection is shown in the display:

>> diff

for the differentiated determination of free, combined and total Copper.

>> free

for the determination of free Copper.

>> total

for the determination of total Copper.

Select the desired determination with the arrow keys [▲] and [▼]. Confirm with [↵] key.

1.1 Methods

Note:

1. If ??? is displayed at the differentiated test result see page 356.

Reagent / Accessories	Form of reagent/Quantity	Order-No.
Set COPPER No. 1 / No. 2	Tablet / per 100 inclusive stirring rod	517691BT
COPPER No. 1	Tablet / 100	513550BT
COPPER No. 2	Tablet / 100	513560BT

1.1 Methods



Copper, differentiated determination with Tablet

0.05 – 1 mg/l Cu

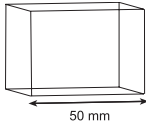

1. Fill a clean 50 mm cell with **water sample**.
2. Place the cell in the sample chamber making sure that the positioning is correct.
3. Press **ZERO** key.
4. Remove the cell from the sample chamber. Empty the cell and dry completely.
5. Fill a beaker with **10 ml water sample**.
6. Add **one COPPER No. 1 tablet** straight from the foil and crush the tablet using a clean stirring rod. Dissolve the tablet.
7. Fill the 50 mm cell with the coloured test solution.
8. Place the cell in the sample chamber making sure that the positioning is correct.
9. Press **TEST** key.
10. Remove the cell from the sample chamber and return the coloured test solution completely back into the beaker.
12. Add **one COPPER No. 2 tablet** straight from the foil to the same water sample and crush the tablet using a clean stirring rod. Dissolve the tablet.

prepare Zero
press ZERO

Zero accepted
prepare T1
press TEST

1.1 Methods

12. Fill the 50 mm cell with the coloured test solution.
13. Place the cell in the sample chamber making sure that the positioning is correct.
14. Press **TEST** key.

T1 accepted
prepare T2
press TEST

The result is shown in the display in:

* ** mg/l free Cu
, ** mg/l comb Cu
, ** mg/l tot Cu

mg/l free Copper
mg/l combined Copper
mg/l total Copper

1.1 Methods

1

4

9

Copper, free with Tablet

0.05 – 1 mg/l Cu

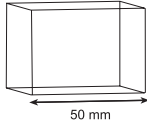

1. Fill a clean 50 mm cell with **water sample**.
2. Place the cell in the sample chamber making sure that the positioning is correct.
3. Press **ZERO** key.
4. Remove the cell from the sample chamber. Empty the cell and dry completely.
5. Fill a beaker with **10 ml water sample**.
6. Add **one COPPER No. 1 tablet** straight from the foil and crush the tablet using a clean stirring rod. Dissolve the tablet.
7. Fill the 50 mm cell with the coloured test solution.
8. Place the cell in the sample chamber making sure that the positioning is correct.
9. Press **TEST** key.

prepare Zero
press ZERO

Zero accepted
prepare Test
press TEST

The result is shown in the display in mg/l Copper.

1.1 Methods



Copper, total with Tablet

0.05 – 1 mg/l Cu

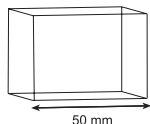

**prepare Zero
press ZERO**

1. Fill a clean 50 mm cell with **water sample**.
2. Place the cell in the sample chamber making sure that the positioning is correct.
3. Press **ZERO** key.
4. Remove the cell from the sample chamber. Empty the cell and dry completely.
5. Fill a beaker with **10 ml water sample**.
6. Add **one COPPER No. 1 tablet** and **one COPPER No. 2 tablet** straight from the foil and crush the tablets using a clean stirring rod. Dissolve the tablets.
7. Fill the 50 mm cell with the coloured test solution.
8. Place the cell in the sample chamber making sure that the positioning is correct.

**Zero accepted
prepare Test
press TEST**

9. Press **TEST** key.

The result is shown in the display in mg/l total Copper.

1.1 Methods

1 5 0

Copper, differentiated determination with Tablet

0.5 – 5 mg/l Cu



Ø 24 mm

prepare Zero
press ZERO

1. Fill a clean vial (24 mm Ø) with **10 ml of the water sample**, close tightly with the cap.

2. Place the vial in the sample chamber making sure that the Σ marks are aligned.

3. Press **ZERO** key.

4. Remove the vial from the sample chamber.

5. Add **one COPPER No. 1 tablet** straight from the foil to the water sample and crush the tablet using a clean stirring rod.

6. Close the vial tightly with the cap and swirl several times until the tablet is dissolved.

7. Place the vial in the sample chamber making sure that the Σ marks are aligned.

Zero accepted
prepare T1
press TEST

8. Press **TEST** key.

9. Remove the vial from the sample chamber.

10. Add **one COPPER No. 2 tablet** straight from the foil to the same water sample and crush the tablet using a clean stirring rod.

11. Close the vial tightly with the cap and swirl several times until the tablet is dissolved.

1.1 Methods

12. Place the vial in the sample chamber making sure that the Σ marks are aligned.

T1 accepted
prepare T2
press TEST

13. Press **TEST** key.

*,** mg/l free Cu
*,** mg/l comb Cu
*,** mg/l total Cu

The result is shown in the display in:

mg/l free Copper
mg/l combined Copper
mg/l total Copper

1.1 Methods

1 5 0

Copper, free with Tablet

0.5 – 5 mg/l Cu



prepare Zero
press ZERO

1. Fill a clean vial (24 mm Ø) with **10 ml of the water sample**, close tightly with the cap.
2. Place the vial in the sample chamber making sure that the Σ marks are aligned.
3. Press **ZERO** key.
4. Remove the vial from the sample chamber.
5. Add **one COPPER No. 1 tablet** straight from the foil to the water sample and crush the tablet using a clean stirring rod.
6. Close the vial tightly with the cap and swirl several times until the tablet is dissolved.
7. Place the vial in the sample chamber making sure that the Σ marks are aligned.
8. Press **TEST** key.

Zero accepted
prepare Test
press TEST

The result is shown in the display in mg/l free Copper.

1.1 Methods

1 5 0

Copper, total with Tablet

0.5 – 5 mg/l Cu



prepare Zero
press ZERO

1. Fill a clean vial (24 mm Ø) with **10 ml of the water sample**, close tightly with the cap.
2. Place the vial in the sample chamber making sure that the Σ marks are aligned.
3. Press **ZERO** key.
4. Remove the vial from the sample chamber.
5. Add **one COPPER No. 1 tablet and one COPPER No. 2 tablet** straight from the foil to the water sample and crush the tablets using a clean stirring rod.
6. Close the vial tightly with the cap and swirl several times until the tablets are dissolved.
7. Place the vial in the sample chamber making sure that the Σ marks are aligned.
8. Press **TEST** key.

Zero accepted
prepare Test
press TEST

The result is shown in the display in mg/l total Copper.

1.1 Methods

1

5

3

Copper, free (Note 1) with Vario Powder Pack

0.05 – 5 mg/l Cu



1. Fill a clean vial (24 mm Ø) with **10 ml of the water sample**, close tightly with the cap.
2. Place the vial in the sample chamber making sure that the Σ marks are aligned.

prepare Zero
press ZERO

3. Press **ZERO** key.
4. Remove the vial from the sample chamber.

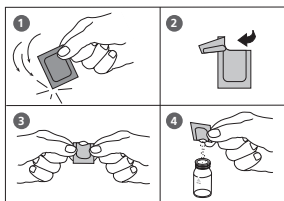

5. Add the contents of **one Vario Cu 1 F10 Powder Pack** straight from the foil to the water sample.
6. Close the vial tightly with the cap and swirl several times to mix the contents (Note 3).
7. Place the vial in the sample chamber making sure that the Σ marks are aligned.

Zero accepted
prepare Test
press TEST

8. Press **TEST** key.
Wait for a **reaction period of 2 minutes**.

Countdown
2:00

After the reaction period is finished the measurement starts automatically.

The result is shown in the display in mg/l Copper.

1.1 Methods

Notes:

1. For determination of total Copper digestion is required.
2. Extremely acid water samples (pH 2 or less) must be adjusted between pH 4 and pH 6 before the reagent is added (with 8 mol/l Potassium hydroxide solution KOH).
Caution: pH values above 6 can lead to Copper precipitation.
3. Accuracy is not affected by undissolved powder.
4. Interferences:

Cyanide, CN ⁻	Cyanide prevents full colour development. Add 0.2 ml Formaldehyde to 10 ml water sample and wait for a reaction time of 4 minutes (Cyanide is masked). After this perform test as described. Multiply the result by 1.02 to correct the sample dilution by Formaldehyde.
Silver, Ag ⁺	If a turbidity remains and turns black, silver interference is likely. Add 10 drops of saturated Potassium chloride solution to 75 ml of water sample. Filtrate through a fine filter. Use 10 ml of the filtered water sample to perform test.

Reagent / Accessories	Form of reagent/Quantity	Order-No.
VARIO Cu 1 F10	Powder Pack / 100	530300

1.1 Methods



Cyanide with Reagent Test

0.005 – 0.2 mg/l CN / 5 – 200 µg/l CN

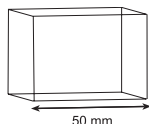

prepare Zero
press ZERO

1. Fill a clean 50 mm cell with **water sample**.
2. Place the cell in the sample chamber making sure that the positioning is correct.
3. Press **ZERO** key.
4. Remove the cell from the sample chamber. Empty the cell and dry completely.
5. Fill a beaker with with **2 ml of water sample** and **8 ml of deionised water**.
6. Add **2 level spoon of No. 4 (white) Cyanide-11** into the prepared water sample. Dissolve reagent.
7. Add **2 level spoon of No. 4 (white) Cyanide-12** and dissolve reagent.
8. Fill the cell with drops of the same size by holding the bottle vertically and squeeze slowly:

3 drops of Cyanide-13

9. Fill the 50 mm cell with the coloured test solution.
10. Place the cell in the sample chamber making sure that the positioning is correct.
11. Press **TEST** key.

Wait for a **reaction period of 10 minutes**.

Zero accepted
prepare Test
press TEST

Countdown
10:00

After the reaction period is finished the measurement starts automatically.

The result is shown in the display as Cyanide.

1.1 Methods

Notes:

1. Only free Cyanide and Cyanides that can be destroyed by Chlorine are determined by this test.
2. In the presence of Thiocyanate, heavy metal complexes, colorants or aromatic amines, the cyanide must be separated out by distillation before analysis is performed.
3. **Store the reagents in closed containers at a temperature of + 15°C to + 25°C.**
4. ▲ mg/l
▼ µg/l

Reagent / Accessories	Form of reagent/Quantity	Order-No.
SET: Cyanid-11/ -12 / -13	Reagent test / 200 (Powder, Liquid reagent)	2418875

1.1 Methods



Cyanide with Reagent Test

0.01 – 0.5 mg/l CN



Ø 24 mm

prepare Zero
press ZERO

1. Fill a clean vial (24 mm Ø) with **2 ml of the water sample and 8 ml of deionised water**, close tightly with the cap.
2. Place the vial in the sample chamber making sure that the Σ marks are aligned.

3. Press **ZERO** key.

4. Remove the vial from the sample chamber.

5. Add **2 level spoon of No. 4 (white) Cyanide-11** into the prepared water sample, close the vial tightly with the cap and invert several times to mix the contents.

6. Add **2 level spoon of No. 4 (white) Cyanide-12**, close the vial tightly with the cap and invert several times to mix the contents.

7. Fill the vial with drops of the same size by holding the bottle vertically and squeeze slowly:

3 drops of Cyanide-13

8. Close the vial tightly with the cap and invert several times to mix the contents.

9. Place the vial in the sample chamber making sure that the Σ marks are aligned.

10. Press **TEST** key.

Wait for a **reaction period of 10 minutes**.

After the reaction period is finished the measurement starts automatically.

The result is shown in the display in mg/l Cyanide.

Zero accepted
prepare Test
press TEST

Countdown
10:00

1.1 Methods

Notes:

1. Only free Cyanide and Cyanides that can be destroyed by Chlorine are determined by this test.
2. In the presence of Thiocyanate, heavy metal complexes, colorants or aromatic amines, the cyanide must be separated out by distillation before analysis is performed.
3. **Store the reagents in closed containers at a temperature of + 15°C to + 25°C.**

Reagent / Accessories	Form of reagent/Quantity	Order-No.
SET: Cyanid-11/ -12 / -13	Reagent test / 200 (Powder, Liquid reagent)	2418875

1.1 Methods

1 6 0

CyA-TEST (Cyanuric acid) with Tablet

0 – 160 mg/l CyA



Ø 24 mm

prepare Zero
press ZERO

1. Fill a clean vial (24 mm Ø) with **5 ml of the water sample** and **5 ml deionised water (Note 1)**, close tightly with the cap.
2. Place the vial in the sample chamber making sure that the Σ marks are aligned.

3. Press **ZERO** key.

4. Remove the vial from the sample chamber.

5. Add **one CyA-TEST tablet** straight from the foil to the prepared water sample and crush the tablet using a clean stirring rod.

6. Close the vial tightly with the cap and swirl several times until the tablet is dissolved (Note 2, 3).

7. Place the vial in the sample chamber making sure that the Σ marks are aligned.

Zero accepted
prepare Test
press TEST

8. Press **TEST** key.

The result is shown in the display in mg/l Cyanuric acid.

1.1 Methods

Notes:

1. Use deionised water or tap water free of Cyanuric acid.
2. If Cyanuric acid is present a cloudy solution will occur.
Small single particles are not necessarily caused by Cyanuric acid.
3. Dissolve the tablet completely (therefore swirl the vial approx. 1 minute).
Un-dissolved particles of the tablet can cause results that are too high.

Reagent / Accessories	Form of reagent/Quantity	Order-No.
CyA-TEST	Tablet / 100	511370BT

1.1 Methods

1

6

5

DEHA (N,N-Diethylhydroxylamine) with Tablet and Liquid Reagent

0.02 – 0.5 mg/l / 20 – 500 µg/l DEHA



Ø 24 mm

prepare Zero
press ZERO

1. Fill a clean vial (24 mm Ø) with **10 ml of the water sample**, close tightly with the cap (Note 2).
2. Place the vial in the sample chamber making sure that the Σ marks are aligned.
3. Press **ZERO** key.

4. Remove the vial from the sample chamber.

5. Fill the vial with drops of the same size by holding the bottle vertically and squeeze slowly:

6 drops (0.25 ml) of DEHA reagent

6. Close the vial tightly with the cap and swirl several times to mix the contents.

7. Add **one DEHA tablet** straight from the foil to the same water sample and crush the tablet using a clean stirring rod.

8. Close the vial tightly with the cap and swirl several times until the tablet is dissolved.

9. Place the vial in the sample chamber making sure that the Σ marks are aligned.

10. Press **TEST** key.

Wait for a **reaction period of 10 minutes**.

After the reaction period is finished the measurement starts automatically.

The result is shown in the display as DEHA.

Zero accepted
prepare Test
press TEST

Countdown
10:00

1.1 Methods

Notes:

1. Application: Testing of residual corrosion inhibitors (Oxygen scavengers) in boiler feed water or condensate.
2. Before using clean the vials with Hydrochloric acid (approx. 20%). Rinse thoroughly with deionised water.
3. Keep the sample dark during colour development time. UV-light (sunlight) causes high measurement results.
4. Ideal temperature for full colour development is $20^{\circ}\text{C} \pm 2^{\circ}\text{C}$.
5. Interferences:
 - Iron (II) interferes at all concentrations:
Repeat the test procedure but without adding the DEHA solution. If the displayed result is above 20 $\mu\text{g/l}$ subtract this value from the DEHA test result.
 - Substances which reduce Iron (III) interfere. Substances which complex iron strongly may interfere also.
 - Substances which may interfere when present in concentrations at:

Borate (as $\text{Na}_2\text{B}_4\text{O}_7$)	500 mg/l
Cobalt	0.025 mg/l
Copper	8.0 mg/l
Hardness (as CaCO_3)	1000 mg/l
Lignosulfonates	0.05 mg/l
Manganese	0.8 mg/l
Molybdenum	80 mg/l
Nickel	0.8 mg/l
Phosphate	10 mg/l
Phosphonates	10 mg/l
Sulfate	1000 mg/l
Zinc	50 mg/l

6. There is an option to change the unit from mg/l to $\mu\text{g/l}$.
The unit mg/l is rounded, e.g.: 25 $\mu\text{g/l}$ = 0.025 mg/l \rightarrow display 0.03 mg/l.

 mg/l
 $\mu\text{g/l}$

Reagent / Accessories	Form of reagent/Quantity	Order-No.
DEHA Solution approx. 60 Tests	Liquid reagent / 15 ml	461185
DEHA Solution approx. 400 Tests	Liquid reagent / 100 ml	461181
DEHA	Tablet / 100	513220BT

1.1 Methods

1 6 7

DEHA (N,N-Diethylhydroxylamin) with Vario Powder Pack and Liquid Reagent

0.02 – 0.5 mg/l / 20 – 500 µg/l DEHA



Use two clean vials (24 mm Ø) and mark one as blank for zeroing (Note 2).

1. Fill a clean vial with **10 ml deionised water** (this is the blank).
2. Fill the second clean vial with **10 ml of the water sample** (this is the sample).
3. Add the contents of **one Vario OXYSCAV 1 Rgt Powder Pack** straight from the foil into each vial.

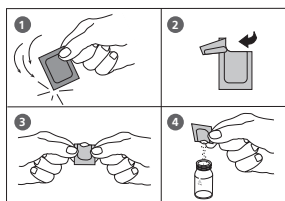

4. Close the vials tightly with the caps and swirl several times to mix the contents.
5. Add **0.20 ml VARIO DEHA 2 Rgt Solution** to each vial (Note 4).

Countdown 1
10:00
start: ↓

6. Close the vials tightly with the caps and swirl several times to mix the contents.
7. Press **[↓]** key.

Wait for a reaction **period of 10 minutes** (Note 5).
After the reaction period is finished proceed as follows:

8. Place the vial (the blank) in the sample chamber making sure that the **∑** marks are aligned.

prepare Zero
press ZERO

9. Press **ZERO** key.
10. Remove the vial from the sample chamber.

Zero accepted
prepare Test
press TEST

11. Place the vial (the sample) in the sample chamber making sure that the **∑** marks are aligned.

12. Press **TEST** key.

The result is shown in the display as DEHA.

1.1 Methods

Notes:

1. Application: Testing of residual corrosion inhibitors (Oxygen scavengers) in boiler feed water or condensate.
2. Before using clean the vials with Hydrochloric acid (approx. 20%). Rinse thoroughly with deionised water.
3. Keep the sample dark during colour development time. UV-light (sunlight) causes high measurement results.
4. Ideal temperature for full colour development is 20°C ± 2°C.
5. Interferences:
 - Iron (II) interferes at all concentrations:
Repeat the test procedure but without adding the DEHA solution. If the displayed result is above 20 µg/l subtract this value from the DEHA test result.
 - Substances which reduce Iron (III) interfere. Substances which complex iron strongly may interfere also.
 - Substances which may interfere when present in concentrations at:

Borate (as Na ₂ B ₄ O ₇)	500 mg/l
Cobalt	0.025 mg/l
Copper	8.0 mg/l
Hardness (as CaCO ₃)	1000 mg/l
Lignosulfonates	0.05 mg/l
Manganese	0.8 mg/l
Molybdenum	80 mg/l
Nickel	0.8 mg/l
Phosphate	10 mg/l
Phosphonates	10 mg/l
Sulfate	1000 mg/l
Zinc	50 mg/l

6. There is an option to change the unit from mg/l to µg/l.
The unit mg/l is rounded, e.g.: 25 µg/l = 0.025 mg/l → display 0.03 mg/l.

 mg/l
 µg/l

Reagent / Accessories	Form of reagent/Quantity	Order-No.
VARIO OXYSCAV 1 Rgt VARIO DEHA 2 Rgt Solution	Set (100 Tests) Powder Pack / 200 Liquid reagent / 100 ml	536000

1.1 Methods

1 7 0

Fluoride

0.05 – 1.5 mg/l F



prepare Zero
press ZERO

- Caution: See notes!**
1. Fill a clean vial (24 mm Ø, Note 8) with **exactly 10 ml of water sample** (Note 4), close tightly with the cap.
 2. Place the vial in the sample chamber making sure that the Σ marks are aligned.
 3. Press **ZERO** key.
 4. Remove the vial from the sample chamber.
 5. Add **exactly 2 ml SPADNS reagent solution** (Note 4) to the water sample.
Caution: Vial is filled up to the top! (Note 8)
 6. Close the vial tightly with the cap and swirl several times to mix the contents.
 7. Place the vial in the sample chamber making sure that the Σ marks are aligned.

Zero accepted
prepare Test
press TEST

8. Press **TEST** key.

The result is shown in the display in mg/l Fluoride.

1.1 Methods

Notes:

1. The same batch of SPADNS reagent solution must be used for adjustment and test.
The adjustment process needs to be performed for each new batch of SPADNS reagent solution (see Standard methods 20th, 1998, APHA, AWWA, WEF 4500 F D., S. 4-82).
The procedure is described in chapter 2.4.5 "Calibration" Mode 40 on page 321.
2. During adjustment and test the same vial should be used for zeroing and test, as different vials may exhibit minor tolerances.
3. The calibration solution and the water samples to be tested should have the same temperature ($\pm 1^\circ\text{C}$).
4. As the test result is highly dependent on exact sample and reagent volumes, the sample and reagent volumes should always be metered by using a 10 ml resp. 2 ml volumetric pipette (class A).
5. The accuracy of the test methods decreases above a level of 1.2 mg/l Fluoride. Although the results are sufficiently accurate for most applications, even more exact results can be achieved by 1:1 dilution of the sample prior to use and subsequent multiplication of the result by 2.
6. SPADNS reagent solution contains Arsenite.
Chlorine concentrations up to 5 mg/l do not interfere.
7. Seawater and wastewater samples must be distilled.
8. It is convenient to use special vials with larger volume.

Reagent / Accessories	Form of reagent/Quantity	Order-No.
SPADNS reagent solution	Liquid reagent / 250 ml	467481
Fluoride standard	Solution / 30 ml	205630

1.1 Methods



Formaldehyde with MERCK Spectroquant® Test, No. 1.14678.0001

1 – 5 mg/l HCHO

Use two clean, empty vials and mark one as blank for zeroing.

1. Pipette **4.5 ml reagent HCHO-1** into each vial.
(CAUTION: Reagent contains concentrated Sulfuric acid! Note 4)
2. Add **one level microspoon of HCHO-2** into each vial.
3. Close the vials tightly with the caps and shake vigorously until the reagent is completely dissolved.
4. Fill one of the prepared vials with **3 ml of deionised water (this is the blank)**.
5. Fill the second prepared vial with **3 ml of the water sample (this is the test solution)**.
6. Close the vials tightly with the caps and swirl several times to mix the contents.
7. Press **[↵]** key.
Wait for a **reaction period of 10 minutes**.

After the reaction period is finished proceed as follows:

8. Fill the **10 mm cell** with the prepared **blank**.
9. Place the cell in the sample chamber making sure that the positioning is correct.
10. Press **ZERO** key.
11. Remove the cell from the sample chamber. Empty the cell and dry completely.
12. Fill the **10 mm cell** with the **test solution**.
13. Place the cell in the sample chamber making sure that the positioning is correct.
14. Press **TEST** key.

The result is shown in the display in mg/l Formaldehyde.

Countdown
10:00
start: ↵



10 mm

prepare Zero
press ZERO

Zero accepted
prepare Test
press TEST

1.1 Methods

Notes:

1. This method is adapted from MERCK.
2. Before performing the test read the original test instructions (delivered with the test) and the MSDS (available at www.merckmillipore.com).
3. Spectroquant® is a registered trade mark of the company MERCK KGaA.
4. Appropriate safety precautions and good lab technique should be used during the whole procedure.
5. Because reaction depends on temperature, **sample and tube temperature must be between 20 and 25°C**.
6. Sample volume should always be metered by using volumetric pipette (class A).

Reagent / Accessories	Form of reagent/Quantity	Order-No.
MERCK Spectroquant® 1.14678.0001	Reagent Test / approx. 50-75 Tests	420751

1.1 Methods



Formaldehyde with MERCK Spectroquant® Test, No. 1.14678.0001

0.02 – 1 mg/l HCHO

Use two clean, empty vials and mark one as blank for zeroing.

1. Pipette **4.5 ml reagent HCHO-1** into each vial.
(CAUTION: Reagent contains concentrated Sulfuric acid! Note 4)
2. Add **one level microspoon of HCHO-2** into each vial.
3. Close the vials tightly with the caps and shake vigorously until the reagent is completely dissolved.
4. Fill one of the prepared vials with **3 ml of deionised water (this is the blank)**.
5. Fill the second prepared vial with **3 ml of the water sample (this is the test solution)**.
6. Close the vials tightly with the caps and swirl several times to mix the contents.
7. Press **[↵]** key.
Wait for a **reaction period of 10 minutes**.

Countdown
10:00
start: ↵

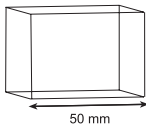

After the reaction period is finished proceed as follows:

8. Fill the **50 mm cell** with the prepared **blank**.
9. Place the cell in the sample chamber making sure that the positioning is correct.
10. Press **ZERO** key.
11. Remove the cell from the sample chamber. Empty the cell and dry completely.
12. Fill the **50 mm cell** with the **test solution**.
13. Place the cell in the sample chamber making sure that the positioning is correct.
14. Press **TEST** key.

prepare Zero
press ZERO

Zero accepted
prepare Test
press TEST

The result is shown in the display in mg/l Formaldehyde.

1.1 Methods

Notes:

1. This method is adapted from MERCK.
2. Before performing the test read the original test instructions (delivered with the test) and the MSDS (available at www.merckmillipore.com).
3. Spectroquant® is a registered trade mark of the company MERCK KGaA.
4. Appropriate safety precautions and good lab technique should be used during the whole procedure.
5. Because reaction depends on temperature, **sample and tube temperature must be between 20 and 25°C**.
6. Sample volume should always be metered by using volumetric pipette (class A).

Reagent / Accessories	Form of reagent/Quantity	Order-No.
MERCK Spectroquant® 1.14678.0001	Reagent Test / approx. 50-75 Tests	420751

1.1 Methods



Formaldehyde with MERCK Spectroquant® Cell Test, No. 1.14500.0001

0,1 – 5 mg/l HCHO



Use two clean Reagent tubes and mark one as blank for zeroing.

∅ 16 mm

1. Add **one level microspoon of HCHO-1K** into each vial.

2. Close the vials tightly with the caps and swirl vigorously until the reagent is dissolved completely.

3. Add **2 ml deionised water** in the vial marked as blank (**this is the blank, note 6**).

4. Fill the second prepared vial with **2 ml of the water sample (this is the test solution, note 6)**.

5. Close the vials tightly with the caps.

Hold the vials by the cap and carefully invert several times to mix the contents. (**CAUTION: Vial becomes hot!**)

6. Place the vial (**the blank**) in the sample chamber making sure that the  marks are aligned.

7. Press **ZERO** key.

8. Remove the vial from the sample chamber.

9. Press [] key.

Wait for a **reaction period of 5 minutes**.

After the reaction period is finished proceed as follows:

Zero vorbereiten
ZERO drücken

Count-Down
5:00
Start: 

1.1 Methods

10. Place the vial (**the sample**) in the sample chamber making sure that the  marks are aligned.

**Zero akzeptiert
Test vorbereiten
TEST drücken**

11. Press **TEST** key.

The result is shown in the display in mg/l Formaldehyde.

Notes:

1. This method is adapted from MERCK.
2. Before performing the test read the original test instructions (delivered with the test) and the MSDS (available at www.merckmillipore.com).
3. Spectroquant® is a registered trade mark of the company MERCK KGaA.
4. Appropriate safety precautions and good lab technique should be used during the whole procedure.
5. Because reaction depends on temperature, **sample and tube temperature must be between 20 and 25°C**.
6. Sample volume should always be metered by using volumetric pipette (class A).
7. Store the reagents in closed containers at a temperature of + 15°C to + 25°C.
8. The test sample should have a pH of between 0 and 13.

Reagent / Accessories	Form of reagent/Quantity	Order-No.
MERCK Spectroquant® 1.14500.0001	Cell Test / 25 Tests	420752

1.1 Methods



Hardness, total with Tablet

2 – 50 mg/l CaCO₃



Ø 24 mm

prepare Zero
press ZERO

1. Fill a clean vial (24 mm Ø) with **10 ml of the water sample**, close tightly with the cap.
2. Place the vial in the sample chamber making sure that the Σ marks are aligned.
3. Press **ZERO** key.
4. Remove the vial from the sample chamber.
5. Add **one HARDCHECK P tablet** straight from the foil to the water sample and crush the tablet using a clean stirring rod.
6. Close the vial tightly with the cap and swirl gently several times to dissolve the tablet.
7. Place the vial in the sample chamber making sure that the Σ marks are aligned.

Zero accepted
prepare Test
press TEST

Countdown
5:00

8. Press **TEST** key.

Wait for a **reaction period of 5 minutes**.

After the reaction period is finished the measurement starts automatically.

The result is shown in the display as total Hardness.

1.1 Methods

Notes:

1. Strong alkaline or acidic water samples must be adjusted between pH 4 and pH 10 before the tablet is added (use 1 mol/l Hydrochloric acid resp. 1 mol/l Sodium hydroxide).
2. Conversion table:

	mg/l CaCO ₃	°dH	°fH	°eH
1 mg/l CaCO ₃	----	0.056	0.10	0.07
1 °dH	17.8	----	1.78	1.25
1 °fH	10.0	0.56	----	0.70
1 °eH	14.3	0.80	1.43	----

3. ▲ CaCO₃
 °dH
 °eH
 °fH
 ▼ °aH

Reagent / Accessories	Form of reagent/Quantity	Order-No.
HARDCHECK P	Tablet / 100	515660BT

1.1 Methods



Hardness, total HR with Tablet

20 – 500 mg/l CaCO₃



Ø 24 mm

prepare Zero
press ZERO

1. Fill a clean vial (24 mm Ø) with **1 ml of the water sample** and **9 ml of deionised water**, close tightly with the cap.
2. Place the vial in the sample chamber making sure that the Σ marks are aligned.

3. Press **ZERO** key.

4. Remove the vial from the sample chamber.

5. Add **one HARDCHECK P tablet** straight from the foil to the water sample and crush the tablet using a clean stirring rod.

6. Close the vial tightly with the cap and swirl gently several times to dissolve the tablet.

7. Place the vial in the sample chamber making sure that the Σ marks are aligned.

8. Press **TEST** key.

Wait for a **reaction period of 5 minutes**.

After the reaction period is finished the measurement starts automatically.

The result is shown in the display as total Hardness.

Zero accepted
prepare Test
press TEST

Countdown
5:00

1.1 Methods

Notes:

1. Strong alkaline or acidic water samples must be adjusted between pH 4 and pH 10 before the tablet is added (use 1 mol/l Hydrochloric acid resp. 1 mol/l Sodium hydroxide).
2. Conversion table:

	mg/l CaCO ₃	°dH	°fH	°eH
1 mg/l CaCO ₃	----	0.056	0.10	0.07
1 °dH	17.8	----	1.78	1.25
1 °fH	10.0	0.56	----	0.70
1 °eH	14.3	0.80	1.43	----

3. ▲ CaCO₃
°dH
°eH
°fH
▼ °aH

Reagent / Accessories	Form of reagent/Quantity	Order-No.
HARDCHECK P	Tablet / 100	515660BT

1.1 Methods

2 0 5

Hydrazine with Powder Reagent

0.05 – 0.5 mg/l N_2H_4 / 50 – 500 $\mu g/l$ N_2H_4



prepare Zero
press ZERO

1. Fill a clean vial (24 mm Ø) with **10 ml of the water sample** (Note 1, 2), close tightly with the cap.
2. Place the vial in the sample chamber making sure that the Σ marks are aligned.
3. Press **ZERO** key.

4. Remove the vial from the sample chamber.
5. Add **1 g HYDRAZINE test powder** (Note 3) to the water sample.
6. Close the vial tightly with the cap and swirl several times to mix the contents.

Countdown
10:00
start: ↓

7. Press **[↓]** key.
Wait for a **reaction period of 10 minutes**.

After the reaction period is finished proceed as follows:

8. The slight turbidity occurring when the reagent is added must be removed by filtration (Note 4).
9. Place the vial in the sample chamber making sure that the Σ marks are aligned.
10. Press **TEST** key.

Zero accepted
prepare Test
press TEST

The result is shown in the display as Hydrazine.

1.1 Methods

Notes:

1. If the water sample is cloudy, you must filter it before performing the zero calibration.
2. The temperature of the water sample should not exceed 21°C.
3. Using the Hydrazine spoon: 1 g is equivalent to one level spoon.
4. Qualitative folded filter papers for medium precipitates are recommended.
5. In order to check whether the reagent has aged (if it has been stored for a lengthy period), perform the test as described above using tap water. If the result is above the detection limit of 0.05 mg/l, you should only use the reagent with reservations as there may be a major deviation in results.
6. There is an option to change the unit from mg/l to µg/l.
The unit mg/l is rounded, e.g.: 25 µg/l = 0.025 mg/l → display 0.03 mg/l.

▲ mg/l

▼ µg/l

Reagent / Accessories	Form of reagent/Quantity	Order-No.
Hydrazin Test Powder	Powder / 30 g	462910
Spoon		384930

1.1 Methods

2 0 6

Hydrazine with Vario Liquid Reagent

0.005 – 0.6 mg/l N_2H_4 / 5 – 600 $\mu\text{g/l}$ N_2H_4



Ø 24 mm

Use two clean vials (24 mm Ø) and mark one as blank for zeroing.

1. Fill a clean vial with **10 ml deionised water** (this is the blank).
2. Add **1 ml VARIO Hydra 2 Rgt Solution** into the vial (Note 3).
3. Close the vial tightly with the cap and swirl several times to mix the contents.
4. Place the vial (the blank) in the sample chamber making sure that the Σ marks are aligned.
5. Press **ZERO** key.
6. Remove the vial from the sample chamber.
7. Fill the second clean vial with **10 ml water sample** (this is the sample).
8. Add **1 ml VARIO Hydra 2 Rgt Solution** into the vial.
9. Close the vial tightly with the cap and swirl several times to mix the contents.
10. Place the vial (the blank) in the sample chamber making sure that the Σ marks are aligned.
11. Press **TEST** key.
Wait for a **reaction period of 12 minutes**.

prepare Zero
press ZERO

Zero accepted
prepare Test
press TEST

Countdown
12:00

After the reaction period is finished the measurement starts automatically.

The result is shown in the display as Hydrazine.

1.1 Methods

Notes:

1. Samples cannot be preserved and must be analysed immediately.
2. Sample temperature should be $21^{\circ}\text{C} \pm 4^{\circ}\text{C}$.
3. The blank may develop a faint yellow colour due to the reagent.
4. Interferences:
 - Ammonia causes no interferences up to 10 mg/l.
At a concentration of 20 mg/l it is possible that the test result increases by 20 %.
 - Morpholine does not interfere up to 10 mg/l.
 - Highly coloured or turbid samples:
Mix 1 part deionised water with 1 part household bleach. Add 1 drop of this mixture into 25 ml water sample and mix. Use 10 ml prepared sample in place of deionised water in point 1.
Note: at point 7 use the unprepared water sample.
Principle: Hydrazine is oxidised by household bleach. Color interference will be eliminated by zeroing.
5. There is an option to change the unit from mg/l to $\mu\text{g/l}$.
The unit mg/l is rounded, e.g.: $25 \mu\text{g/l} = 0.025 \text{ mg/l} \rightarrow \text{display } 0.03 \text{ mg/l}$.

▲ mg/l
▼ $\mu\text{g/l}$

Reagent / Accessories	Form of reagent/Quantity	Order-No.
VARIO Hydra 2 Rgt Solution	Liquid reagent / 100 ml	531200

1.1 Methods

2 0 9

Hydrogen peroxide with Tablet

0.01 – 0.5 mg/l H₂O₂

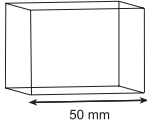

prepare Zero
press ZERO

1. Fill a clean 50 mm cell with **water sample**.
2. Place the cell in the sample chamber making sure that the positioning is correct.
3. Press **ZERO** key.
4. Remove the cell from the sample chamber. Empty the cell and dry completely.
5. Rinse a beaker with the water sample and **empty it, leaving a few drops remaining in the beaker**.
6. Add **one HYDROGENPEROXIDE LR tablet** straight from the foil and crush the tablet using a clean stirring rod.
7. Add **10 ml water sample** and dissolve the tablet.
8. Fill the 50 mm cell with the coloured test solution.
9. Place the cell in the sample chamber making sure that the positioning is correct.

Zero accepted
prepare Test
press TEST

Countdown
2:00

10. Press **TEST** key.

Wait for a **reaction period of 2 minutes**.

After the reaction period is finished the measurement starts automatically.

The result is shown in the display in mg/l Hydrogen peroxide.

1.1 Methods

Notes:

1. Vial cleaning:
As many household cleaners (e.g. dishwasher detergent) contain reducing substances, the subsequent determination of Hydrogen peroxide may show lower results. To avoid any measurement errors, only use glassware free of Chlorine demand.
Preparation: Put all applicable glassware into Sodium hypochlorite solution (0.1 g/l) for one hour, then rinse all glassware thoroughly with deionised water.
2. Preparing the sample:
When preparing the sample, the loss of Hydrogen peroxide, e.g. by pipetting or shaking, must be avoided. The analysis must take place immediately after taking the sample.
3. The DPD colour development is carried out at a pH value of 6.2 to 6.5. The reagent tablet therefore contains a buffer for pH adjustment. Strong alkaline or acidic water samples must be adjusted to between pH 6 and pH 7 before the reagent is added (use 0.5 mol/l Sulfuric acid resp. 1 mol/l Sodium hydroxide).
4. Exceeding the measuring range:
Concentrations above 5 mg/l Hydrogen peroxide can lead to results showing 0 mg/l. In this case, the water must be diluted with water free of Bromine. 10 ml of the diluted sample should be mixed with the reagent and the measurement repeated.
5. Oxidising agents such as Chlorine, Ozone etc. interfere as they react in the same way as Hydrogen peroxide.

Reagent / Accessories	Form of reagent/Quantity	Order-No.
Hydrogenperoxide LR	Tablet / 100	512380BT

1.1 Methods



Hydrogen peroxide with Tablet

0.03 – 1.5 mg/l H₂O₂



Ø 24 mm

prepare Zero
press ZERO

1. Fill a clean vial (24 mm Ø) with **10 ml of the water sample**, close tightly with the cap.
2. Place the vial in the sample chamber making sure that the Σ marks are aligned.
3. Press **ZERO** key.
4. Remove the vial from the sample chamber and **empty it, leaving a few drops remaining in the vial.**
5. Add **one HYDROGENPEROXIDE LR tablet** straight from the foil and crush the tablet using a clean stirring rod.
6. Add water sample to the 10 ml mark.
7. Close the vial tightly with the cap and swirl several times until the tablet is dissolved.
8. Place the vial in the sample chamber making sure that the Σ marks are aligned.

Zero accepted
prepare Test
press TEST

Countdown
2:00

9. Press **TEST** key.

Wait for a **reaction period of 2 minutes.**

After the reaction period is finished the measurement starts automatically.

The result is shown in the display in mg/l Hydrogen peroxide.

1.1 Methods

Notes:

1. Vial cleaning:
As many household cleaners (e.g. dishwasher detergent) contain reducing substances, the subsequent determination of Hydrogen peroxide may show lower results. To avoid any measurement errors, only use glassware free of Chlorine demand.
Preparation: Put all applicable glassware into Sodium hypochlorite solution (0.1 g/l) for one hour, then rinse all glassware thoroughly with deionised water.
2. Preparing the sample:
When preparing the sample, the loss of Hydrogen peroxide, e.g. by pipetting or shaking, must be avoided. The analysis must take place immediately after taking the sample.
3. The DPD colour development is carried out at a pH value of 6.2 to 6.5. The reagent tablet therefore contains a buffer for the pH adjustment.
Strong alkaline or acid water samples must be adjusted between pH 6 and pH 7 before the tablet is added (use 0.5 mol/l Sulfuric acid resp. 1 mol/l Sodium hydroxide).
4. Exceeding the measuring range:
Concentrations above 5 mg/l Hydrogen peroxide can lead to results showing 0 mg/l. In this case, the water sample must be diluted with water free of Hydrogen peroxide. 10 ml of the diluted sample should be mixed with the reagent and the measurement repeated.
5. Oxidising agents such as Chlorine, Ozone etc. interfere as they react in the same way as Hydrogen peroxide.

Reagent / Accessories	Form of reagent/Quantity	Order-No.
Hydrogenperoxide LR	Tablet / 100	512380BT

1.1 Methods

2

1

5

Iodine with Tablet

0.05 – 3.6 mg/l I



Ø 24 mm

prepare Zero
press ZERO

1. Fill a clean vial (24 mm Ø) with **10 ml of the water sample**, close tightly with the cap.
2. Place the vial in the sample chamber making sure that the Σ marks are aligned.
3. Press **ZERO** key.
4. Remove the vial from the sample chamber, **empty the vial leaving a view drops in.**
5. Add **one DPD No. 1 tablet** straight from the foil to the water sample and crush the tablet using a clean stirring rod.
6. Add water sample to the 10 ml mark.
7. Close the vial tightly with the cap and swirl several times until the tablet is dissolved.
8. Place the vial in the sample chamber making sure that the Σ marks are aligned.

Zero accepted
prepare Test
press TEST

9. Press **TEST** key.

The result is shown in the display in mg/l Iodine.

1.1 Methods

Notes:

1. Oxidising reagents, such as Chlorine, Bromine, etc. interfere as they react in the same way as Iodine.

Reagent / Accessories	Form of reagent/Quantity	Order-No.
DPD No. 1	Tablet / 100	511050BT

1.1 Methods

2 1 8

Iron with Tablet

0.1 – 1 mg/l Fe

* Determination of total dissolved Iron Fe^{2+} and Fe^{3+}



10 mm

2 1 9

Iron with Tablet

0.01 – 0.5 mg/l Fe

* Determination of total dissolved Iron Fe^{2+} and Fe^{3+}

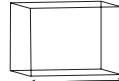

50 mm

2 2 0

Iron with Tablet

0.1 – 1 mg/l Fe

* Determination of total dissolved Iron Fe^{2+} and Fe^{3+}



Ø 24 mm

2 2 2

Iron with Vario Powder Pack

0.1 – 3 mg/l Fe

* Determination of all dissolved iron and most undissolved forms of iron.



Ø 24 mm

2 2 3

Iron, total with Vario Powder Pack

0.1 – 1.8 mg/l Fe

* Determination of all dissolved iron and most undissolved forms of iron; most undissolved iron oxides are recovered by the reagent.



Ø 24 mm

* This information refers to analysis of the water sample without digestion.

Further information can be found in the method notes.

1.1 Methods

Notes:

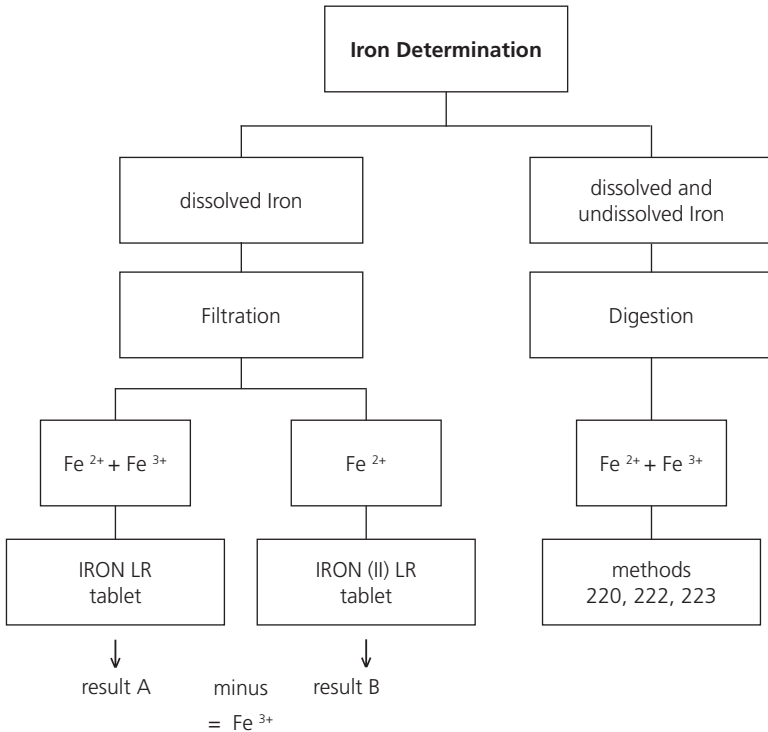

Digestion procedure for the determination of total dissolved and undissolved iron.

1. Add 1 ml of concentrated sulfuric acid to 100 ml water sample. Heat and boil for 10 minutes or until all particles are dissolved. After cooling down, the sample is set to a pH-value of 3 to 6 by using ammonia solution. Refill with deionised water to the previous volume of 100 ml and mix well. 10 ml of this pre-treated solution is used for the following analysis. Perform as described by the selected test method.
2. Water which has been treated with organic compounds like corrosion inhibitors must be oxidised where necessary to break down the iron. Therefore add 1 ml concentrated sulfuric acid and 1 ml concentrated nitric acid to 100 ml water sample and boil to approx. half volume. After cooling down, proceed as described above.

1.1 Methods

2

1

8

Iron with Tablet

0.1 – 1 mg/l Fe



10 mm

prepare Zero
press ZERO

1. Fill a clean 10 mm cell with **water sample**.
2. Place the cell in the sample chamber making sure that the positioning is correct.
3. Press **ZERO** key.
4. Remove the cell from the sample chamber. Empty the cell and dry completely.
5. Fill a beaker with **10 ml water sample**.
6. Add **one IRON LR tablet** straight from the foil and crush the tablet using a clean stirring rod. Dissolve the tablet.
7. Fill the 10 mm cell with the coloured test solution.
8. Place the cell in the sample chamber making sure that the positioning is correct.
9. Press **TEST** key.

Zero accepted
prepare Test
press TEST

Countdown
5:00

Wait for a **reaction period of 5 minutes**.

After the reaction period is finished the measurement starts automatically.

The result is shown in the display in mg/l Iron.

1.1 Methods

Notes:

1. This method determines the total dissolved Iron as Fe^{2+} and Fe^{3+} .
2. For the determination of Fe^{2+} ions the IRON (II) LR tablet is used, as described above, instead of the IRON LR tablet.
3. For the determination of total dissolved and undissolved iron digestion is required. An example is described on page 155.

Reagent / Accessories	Form of reagent/Quantity	Order-No.
IRON LR	Tablet / 100	515370BT
IRON (II) LR	Tablette / 100	515420BT

1.1 Methods



Iron with Tablet

0.01 – 0.5 mg/l Fe

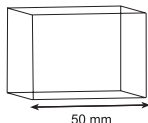

1. Fill a clean 50 mm cell with **water sample**.
2. Place the cell in the sample chamber making sure that the positioning is correct.
3. Press **ZERO** key.

prepare Zero
press ZERO

4. Remove the cell from the sample chamber. Empty the cell and dry completely.
5. Fill a beaker with **10 ml water sample**.
6. Add **one IRON LR tablet** straight from the foil and crush the tablet using a clean stirring rod. Dissolve the tablet.

7. Fill the 50 mm cell with the coloured test solution.
8. Place the cell in the sample chamber making sure that the positioning is correct.

Zero accepted
prepare Test
press TEST

9. Press **TEST** key.

Wait for a **reaction period of 5 minutes**.

Countdown
5:00

After the reaction period is finished the measurement starts automatically.

The result is shown in the display in mg/l Iron.

1.1 Methods

Notes:

1. This method determines the total dissolved Iron as Fe^{2+} and Fe^{3+} .
2. For the determination of Fe^{2+} ions the IRON (II) LR tablet is used, as described above, instead of the IRON LR tablet.
3. For the determination of total dissolved and undissolved iron digestion is required. An example is described on page 155.

Reagent / Accessories	Form of reagent/Quantity	Order-No.
IRON LR	Tablet / 100	515370BT
IRON (II) LR	Tablette / 100	515420BT

1.1 Methods

2 2 0

Iron (Note 1) with Tablet

0.1 – 1 mg/l Fe

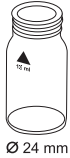

prepare Zero
press ZERO

1. Fill a clean vial (24 mm Ø) with **10 ml of the water sample**, close tightly with the cap.
2. Place the vial in the sample chamber making sure that the Σ marks are aligned.
3. Press **ZERO** key.
4. Remove the vial from the sample chamber.
5. Add **one IRON LR tablet** straight from the foil to the water sample and crush the tablet using a clean stirring rod.
6. Close the vial tightly with the cap and swirl several times until the tablet is dissolved.
7. Place the vial in the sample chamber making sure that the Σ marks are aligned.

Zero accepted
prepare Test
press TEST

Countdown
5:00

8. Press **TEST** key.

Wait for a **reaction period of 5 minutes**.

After the reaction period is finished the measurement starts automatically.

The result is shown in the display in mg/l Iron.

1.1 Methods

Notes:

1. This method determines the total dissolved Iron as Fe²⁺ and Fe³⁺.
2. For the determination of Fe²⁺ ions the IRON (II) LR tablet is used, as described above, instead of the IRON LR tablet.
3. For the determination of total dissolved and undissolved iron digestion is required. An example is described on page 155.

Reagent / Accessories	Form of reagent/Quantity	Order-No.
IRON LR	Tablet / 100	515370BT
IRON (II) LR	Tablette / 100	515420BT

1.1 Methods



Iron (Note 1) with Vario Powder Pack

0.1 – 3 mg/l Fe



Ø 24 mm

prepare Zero
press ZERO

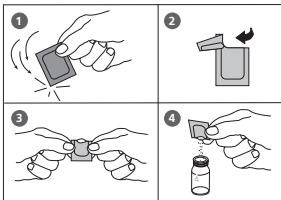

Zero accepted
prepare Test
press TEST

Countdown
3:00

1. Fill a clean vial (24 mm Ø) with **10 ml of the water sample**, close tightly with the cap.
 2. Place the vial in the sample chamber making sure that the marks Σ are aligned.
 3. Press **ZERO** key.
 4. Remove the vial from the sample chamber.
 5. Add the contents of **one Vario Ferro F10 Powder Pack** straight from the foil to the water sample.
 6. Close the vial tightly with the cap and swirl several times to mix the contents (Note 4).
 7. Place the vial in the sample chamber making sure that the Σ marks are aligned.
 8. Press **TEST** key.
- Wait for a **reaction period of 3 minutes** (Note 5).

After the reaction period is finished the measurement starts automatically.

The result is shown in the display in mg/l Iron.

1.1 Methods

Notes:

1. The reagent reacts with all dissolved iron and most undissolved forms of iron in the water sample.
2. Iron oxide requires prior digestion: use mild, vigorous or Digesdahl digestion (e.g. for digestion with acid see page 155).
3. Very strong alkaline or acidic water samples must be adjusted to a pH value between 3 and 5 before analysis.
4. Accuracy is not affected by undissolved powder.
5. Water samples containing visible rust should be allowed to react for at least five minutes.

Reagent / Accessories	Form of reagent/Quantity	Order-No.
VARIO Ferro F10	Powder Pack / 100	530560

1.1 Methods



Iron, total (TPTZ, Note 1) with Vario Powder Pack

0.1 – 1.8 mg/l Fe



Use two clean vials (24 mm Ø) and mark one as blank for zeroing.

1. Fill a clean vial with **10 ml deionised water** (this is the blank).

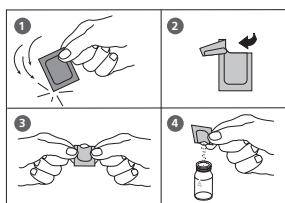

2. Fill the second clean vial with **10 ml of the water sample** (this is the sample).

3. Add the contents of **one Vario IRON TPTZ F10 Powder Pack** straight from the foil into each vial.

4. Close the vials tightly with the caps and swirl several times to mix the contents.

Countdown
3:00
start: ↵

5. Press **[↵]** key.

Wait for a reaction **period of 3 minutes**.

After the reaction period is finished proceed as follows:

6. Place the vial (the blank) in the sample chamber making sure that the **Σ** marks are aligned.

prepare Zero
press ZERO

7. Press **ZERO** key.

8. Remove the vial from the sample chamber.

9. Place the vial (the sample) in the sample chamber making sure that the **Σ** marks are aligned.

Zero accepted
prepare Test
press TEST

10. Press **TEST** key.

The result is shown in the display in mg/l Iron.

1.1 Methods

Notes:

1. For determination of total Iron digestion is required.
TPTZ reagent recovers most insoluble iron oxides without digestion.
2. Rinse all glassware with 1:1 Hydrochloric acid solution first and then rinse with deionised water to remove iron deposits that can cause slightly high results.
3. Strong alkaline or acidic water samples must be adjusted between pH 3 and pH 8 before the reagent is added (use 0.5 mol/l Sulfuric acid resp. 1 mol/l Sodium hydroxide).
4. Interferences:

When interferences occur, colour development is inhibited or a precipitate is formed.

The values below refer to a standard with an iron concentration of 0.5 mg/l.

The following substances do not interfere when present up to the levels given:

Substance	no interference to
Cadmium	4.0 mg/l
Chromium ⁽³⁺⁾	0.25 mg/l
Chromium ⁽⁶⁺⁾	1.2 mg/l
Cobalt	0.05 mg/l
Copper	0.6 mg/l
Cyanide	2.8 mg/l
Manganese	50 mg/l
Mercury	0.4 mg/l
Molybdenum	4.0 mg/l
Nickel	1.0 mg/l
Nitrite Ion	0.8 mg/l

Reagent / Accessories	Form of reagent/Quantity	Order-No.
VARIO IRON TPTZ F10	Powder Pack / 100	530550

1.1 Methods



Lead with MERCK Spectroquant® Test, No. 1.09717.0001

0.1 – 5 mg/l Pb



10 mm

**prepare Zero
press ZERO**

1. Fill a clean 10 mm cell with **water sample**.
2. Place the cell in the sample chamber making sure that the positioning is correct.
3. Press **ZERO** key.
4. Remove the cell from the sample chamber. Empty the cell and dry completely.

**Caution! Reagent Pb-1 contains Potassium Cyanide!
Adhere strictly to the specified dosage sequence!
(Note 4)**

5. Pipette **0.5 ml Reagent Pb-1** into a beaker.
6. Add **0.5 ml Reagent Pb-2** and mix.
7. Add **8 ml water sample** and mix.
8. Fill the 10 mm cell with the coloured test solution.
9. Place the cell in the sample chamber making sure that the positioning is correct.

**Zero accepted
prepare Test
press TEST**

10. Press **TEST** key.

The result is shown in the display in mg/l Lead.

1.1 Methods

Notes:

1. This method is adapted from MERCK.
2. Before performing the test read the original test instructions (delivered with the test) and the MSDS (available at www.merckmillipore.com).
3. Spectroquant® is a registered trade mark of the company MERCK KGaA.
4. Appropriate safety precautions and good lab technique should be used during the whole procedure.
5. Volumes for sample and reagent should always be metered by using volumetric pipettes (class A).
6. The test determines only Pb²⁺-ions. Samples must be pre-treated or decomposed by digestion before colloidal, undissolved and complex-bound lead can be measured.

Reagent / Accessories	Form of reagent/Quantity	Order-No.
MERCK Spectroquant® 1.09717.0001	Tube Test / 50 Tests	420753

1.1 Methods

Lead with MERCK Spectroquant® Cell Test, No. 1.14833.0001

0.1 – 5 mg/l Pb



Procedure A

Select this test for the determination of lead in soft to medium hard waters with a Ca²⁺ contents lower than 70 mg/l (approx. 10°d).



Procedure B

Select this test for the determination of lead in hard to very hard waters with a Ca²⁺ contents between 70 mg/l and 500 mg/l (approx. 10°d to 70°d).

Notes:

1. This method is adapted from MERCK.
2. Before performing the test read the original test instructions (delivered with the test) and the MSDS (available at www.merckmillipore.com).
3. Spectroquant® is a registered trade mark of the company MERCK KGaA.
4. Appropriate safety precautions and good lab technique should be used during the whole procedure.
5. Because reaction depends on temperature, the sample temperature must be between 10 and 40°C.
6. Sample volume should always be metered by using volumetric pipette (class A).
7. The test determines only Pb²⁺-ions. Samples must be pre-treated or decomposed by digestion before undissolved and complex-bound lead can be measured.
8. Store the reagents in closed containers at a temperature of + 15°C to + 25°C.
9. The test sample should have a pH of between 3 and 6.

Reagent / Accessories	Form of reagent/Quantity	Order-No.
MERCK Spectroquant® 1.14833.0001	Tube Test / 25 Tests	420754

1.1 Methods



Lead with MERCK Spectroquant® Cell Test, No. 1.14833.0001

0.1 – 5 mg/l Pb



Procedure A

Use two clean Reagent tubes and mark one as blank for zeroing.

Ø 16 mm

**Caution! Reagent tubes contain Potassium Cyanide!
Adhere strictly to the specified dosage sequence!
(Note 4)**

1. Fill each vial with drops of the same size by holding the bottle vertically and squeeze slowly:
5 drops reagent Pb-1K
2. Close the vials tightly with the caps and invert several times to mix the contents.
3. Add **5 ml deionised water** in the vial marked as blank **(this is the blank, note 6)**.
4. Fill the second prepared vial with **5 ml of the water sample (this is the test solution, note 6)**.
5. Close the vials tightly with the caps and invert several times to mix the contents.
6. Place the vial **(the blank)** in the sample chamber making sure that the Σ marks are aligned.
7. Press **ZERO** key.
8. Remove the vial from the sample chamber.
9. Place the vial **(the sample)** in the sample chamber making sure that the Σ marks are aligned.
10. Press **TEST** key.

The result is shown in the display in mg/l Lead.

Notes: see previous page

prepare Zero
press ZERO

Zero accepted
prepare Test
press TEST

1.1 Methods



Lead with MERCK Spectroquant® Cell Test, No. 1.14833.0001

0,1 – 5 mg/l Pb



Procedure A

Use two clean Reagent tubes and mark one as blank for zeroing.

Ø 16 mm

**Caution! Reagent tubes contain Potassium Cyanide!
Adhere strictly to the specified dosage sequence!
(Note 4)**

1. Fill each vial with drops of the same size by holding the bottle vertically and squeeze slowly:

5 drops reagent Pb-1K



2. Close the vials tightly with the caps and invert several times to mix the contents.
3. Add **5 ml deionised water** in the vial marked as blank **(this is the blank, note 6)**.
4. Fill the second prepared vial with **5 ml of the water sample (this is the test solution, note 6)**.
5. Close the vials tightly with the caps and invert several times to mix the contents.
6. Place the vial **(the blank)** in the sample chamber making sure that the  marks are aligned.

**prepare Zero
press ZERO**

7. Press **ZERO** key.
8. Remove the vial from the sample chamber.

1.1 Methods

Zero accepted
prepare T1
press TEST

9. Place the vial (**the sample**) in the sample chamber making sure that the  marks are aligned.
10. Press **TEST** key.
11. Remove the vial (**the sample**) from the sample chamber and open carefully.
12. Add **1 level microspoon of reagent Pb-2K into the vial (the sample)**.
13. Close the vial tightly with the cap and swirl until the reagent is dissolved completely.
14. Place the vial (**the sample**) in the sample chamber making sure that the  marks are aligned.

T1 accepted
prepare T2
press TEST

15. Press **TEST** key.
The result is shown in the display in mg/l Lead.

Notes: see previous page

1.1 Methods

2 4 0

Manganese with Tablet

0.2 – 4 mg/l Mn



prepare Zero
press ZERO

1. Fill a clean vial (24 mm Ø) with **10 ml of the water sample**, close tightly with the cap.
2. Place the vial in the sample chamber making sure that the Σ marks are aligned.
3. Press **ZERO** key.
4. Remove the vial from the sample chamber.
5. Add **one MANGANESE LR 1 tablet** straight from the foil to the water sample and crush the tablet using a clean stirring rod and dissolve the tablet.
6. Add **one MANGANESE LR 2 tablet** straight from the foil to the same water sample and crush the tablet using a clean stirring rod.
7. Close the vial tightly with the cap and swirl several times until the tablets are dissolved.
8. Place the vial in the sample chamber making sure that the Σ marks are aligned.
9. Press **TEST** key.

Wait for a **reaction period of 5 minutes**.

After the reaction period is finished the measurement starts automatically.

The result is shown in the display in mg/l Manganese.

Zero accepted
prepare Test
press TEST

Countdown
5:00

1.1 Methods

Note:

1. ▲ Mn
MnO₄
▼ KMnO₄

Reagent / Accessories	Form of reagent/Quantity	Order-No.
Set MANGANESE LR No. 1 / No. 2	Tablet / per 100 inclusive stirring rod	517621BT
MANGANESE LR No. 1	Tablet / 100	516080BT
MANGANESE LR No. 2	Tablet / 100	516090BT

1.1 Methods

2 4 2

Manganese LR with Vario Powder Pack

0.01 – 0.7 mg/l Mn



Ø 24 mm

Use two clean vials (24 mm Ø) and mark one as blank for zeroing (Note 1).

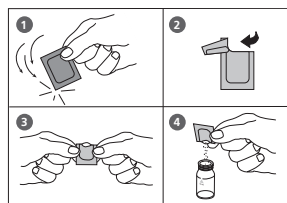

1. Fill a clean vial with **10 ml of deionised water** (this is the blank).
2. Fill the second clean vial with **10 ml of the water sample** (this is the sample).

3. Add the contents of **one Vario Ascorbic Acid Powder Pack** straight from the foil into each vial (Note 2).

4. Close the vials tightly with the caps and swirl several times to mix the contents.

5. Fill each vial with drops of the same size by holding the bottle vertically and squeeze slowly (Note 3):
15 drops of Alkaline Cyanide reagent solution

6. Close the vials tightly with the caps and swirl several times to mix the contents.

7. Fill each vial with drops of the same size by holding the bottle vertically and squeeze slowly:
21 drops of PAN Indicator solution

8. Close the vials tightly with the caps and swirl several times to mix the contents.

Countdown
2:00
start: ↓

9. Press **[↓]** key.
Wait for a **reaction period of 2 minutes** (Note 4).
After the reaction period is finished proceed as follows:

10. Place the vial (the blank) in the sample chamber making sure that the marks are Δ aligned.

prepare Zero
press ZERO

11. Press **ZERO** key.

12. Remove the vial from the sample chamber.

13. Place the vial (the sample) in the sample chamber making sure that the marks are Δ aligned.

Zero accepted
prepare Test
press TEST

14. Press **TEST** key.

The result is shown in the display in mg/l Manganese.

1.1 Methods

Notes:

1. Rinse all glassware with 1:1 Nitric acid solution first and then rinse with deionised water.
2. Water samples that contain more than 300 mg/l CaCO₃ hardness: after adding the Vario Ascorbic Acid powder pack add additionally 10 drops of Rochelle Salt Solution.
3. After addition of the reagent solution "Alkaline-Cyanide" a cloudy or turbid solution may form in some water samples. The turbidity should disappear after point 7.
4. Water samples containing more than 5 mg/l iron should be allowed to react for at least 10 minutes.
5. Conversion:
 $\text{mg/l MnO}_4 = \text{mg/l Mn} \times 2.17$
6. ▲ Mn
MnO₄
▼ KMnO₄

Reagent / Accessories	Form of reagent/Quantity	Order-No.
Set VARIO Ascorbic Acid VARIO Alkaline-Cyanide VARIO PAN Indicator	Powder Pack / 100 Liquid reagent / 60 ml Liquid reagent / 60 ml	535090
VARIO Rochelle Salzlösung	30 ml	530640

1.1 Methods

2 4 3

Manganese HR with Vario Powder Pack

0.1 – 18 mg/l Mn



Ø 24 mm

prepare Zero
press ZERO

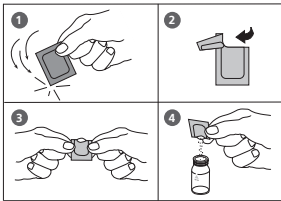

1. Fill a clean vial (24 mm Ø) with **10 ml of the water sample**, close tightly with the cap.
2. Place the vial in the sample chamber making sure that the Σ marks are aligned.
3. Press **ZERO** key.
4. Remove the vial from the sample chamber.

5. Add the contents of **one Vario Manganese Citrate Buffer F10 Powder Pack** straight from the foil to the water sample.
6. Close the vial tightly with the cap and swirl several times to mix the contents.
7. Add the contents of **one Vario Sodium periodate F10 Powder Pack** straight from the foil to the same water sample.

8. Close the vial tightly with the cap and swirl several times to mix the contents.
9. Place the vial in the sample chamber making sure that the Σ marks are aligned

10. Press **TEST** key.

Wait for a **reaction period of 2 minutes**.

After the reaction period is finished the measurement starts automatically.

The result is shown in the display in mg/l Mangan.

Zero accepted
prepare Test
press TEST

Countdown
2:00

1.1 Methods

Notes:

1. This test is applicable for the determination of soluble Manganese in water and wastewater.
2. Highly buffered water samples or extreme pH values may exceed the buffering capacity of the reagents and requires sample pre-treatment.
If samples were acidified for storing, adjust the pH between 4 and 5 with 5 mol/l (5 N) Sodium hydroxide before test. Do not exceed pH 5, as manganese may precipitate.
3. Interferences:

Interfering substance	Interference level
Calcium	greater than 700 mg/l
Chloride	greater than 70 000 mg/l
Iron	greater than 5 mg/l
Magnesium	greater than 100 000 mg/l

4. ▲ Mn
MnO₄
▼ KMnO₄

Reagent / Accessories	Form of reagent/Quantity	Order-No.
Set VARIO Manganese Citrate Buffer F10 VARIO Sodiumperiodate F10	Powder Pack / 100 Powder Pack / 100	535100

1.1 Methods

2 5 0

Molybdate / Molybdenum with Tablet

1 – 30 mg/l MoO_4 / 0.6 – 18 mg/l Mo



Ø 24 mm

prepare Zero
press ZERO

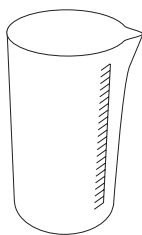

1. Fill a clean vial (24 mm Ø) with **10 ml of the water sample**, close tightly with the cap.
2. Place the vial in the sample chamber making sure that the Σ marks are aligned.
3. Press **ZERO** key.
4. Remove the vial from the sample chamber and **empty the vial**.
5. Fill **20 ml of water sample** in a 100 ml beaker.
6. Add **one MOLYBDATE HR No. 1 tablet** straight from the foil to the water sample and crush the tablet using a clean stirring rod.
7. Add **one MOLYBDATE HR No. 2 tablet** straight from the foil to the same water sample and crush the tablet using a clean stirring rod.
8. Dissolve the tablets using a clean stirring rod.
9. Rinse out the vial with the prepared water sample and then fill to the 10 ml mark.
10. Close the vial tightly with the cap.
11. Place the vial in the sample chamber making sure that the Σ marks are aligned.
12. Press **TEST** key.

Zero accepted
prepare Test
press TEST

The result is shown in the display in mg/l Molybdate / Molybdenum.

1.1 Methods

Notes:

1. The tablets must be added in the correct sequence.
2. Under test conditions (pH 3.8 – 3.9) iron does not interfere nor do other metals at levels likely to be found in industrial water systems.
3. Conversions:
 $\text{mg/l Mo} = \text{mg/l MoO}_4 \times 0.6$
 $\text{mg/l Na}_2\text{MoO}_6 = \text{mg/l MoO}_4 \times 1.3$
4. ▲ MoO₄
Mo
▼ Na₂MoO₄

Reagent / Accessories	Form of reagent/Quantity	Order-No.
Set MOLYBDATE HR No. 1 / No. 2	Tablet / per 100 inclusive stirring rod	517631BT
MOLYBDATE HR No. 1	Tablet / 100	513060BT
MOLYBDATE HR No. 2	Tablet / 100	513070BT

1.1 Methods

2 5 1

Molybdate / Molybdenum LR mit Vario Powder Pack

0.05 – 5.0 mg/l MoO_4 / 0.03 – 3 mg/l Mo

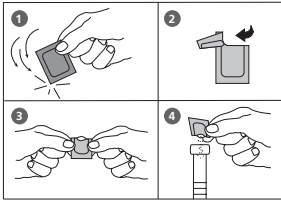
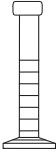

Ø 24 mm

1. Fill a clean Mixing Cylinder (25 ml) with **20 ml of the water sample**.
2. Add the contents of **one Vario Molybdenum 1 LR F20 Powder Pack** straight from the foil into the water sample (20 ml).
3. Close the Mixing Cylinder tightly with a stopper and swirl several times to dissolve the powder.
4. Use two clean vials (24 mm Ø) and mark one as blank for zeroing.
5. Fill each vial with 10 ml of pre prepared water sample.
6. Close the blank tightly with the cap.
7. Add **0,5 ml of Vario Molybdenum 2 LR solution** to the sample.
8. Close the vial tightly with the cap and invert several times to mix the contents.
9. Press **[↵]** key.
Wait for a reaction period of 2 minutes.
10. After the reaction period is finished proceed as follows:
11. Place the blank in the sample chamber making sure that the **X** marks are aligned.

Count-Down 1

2:00

Start: ↵

1.1 Methods

**prepare Zero
press ZERO**

12. Press **ZERO** key.
13. Remove the vial from the sample chamber.
14. Place the sample in the sample chamber making sure that the Σ marks are aligned.

**Zero accepted
prepare Test
press TEST**

15. Press **TEST** key.

The result is shown in the display in mg/l Molybdate / Molybdenum.

Notes:

1. Strong alkaline or acidic water samples must be adjusted between pH 3 and pH 5 before the reagent is added (use 0.5 mol/l Sulfuric acid resp. 1 mol/l Sodium hydroxide).
2. Before using clean the vials with Hydrochloric acid (approx. 20%). Rinse thoroughly with deionised water.
3. ▲ MoO_4
Mo
▼ Na_2MoO_4

Reagent / Accessories	Form of reagent/Quantity	Order-No.
Set VARIO Molybdenum 1 LR F20 VARIO Molybdenum 2 LR	Powder Pack / 100 Liquid reagent / 50 ml	535450
Mixing Cylinder	25 ml	19802650

1.1 Methods

2 5 2

Molybdate / Molybdenum HR with Vario Powder Pack

0.5 – 66 mg/l MoO₄ / 0.3 – 40 mg/l Mo



Ø 24 mm

prepare Zero
press ZERO

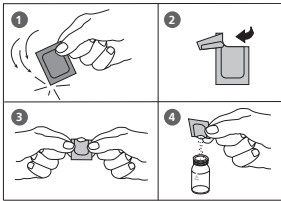

1. Fill a clean vial (24 mm Ø) with **10 ml of the water sample**, close tightly with the cap.
2. Place the vial in the sample chamber making sure that the Σ marks are aligned.
3. Press **ZERO** key.
4. Remove the vial from the sample chamber.
5. Add the contents of **one Vario Molybdenum HR 1 F10 Powder Pack** straight from the foil to the water sample.
6. Close the vial tightly with the cap and swirl several times to mix the contents.
7. Add the contents of **one Vario Molybdenum HR 2 F10 Powder Pack** straight from the foil to the same water sample.
8. Close the vial tightly with the cap and swirl several times to mix the contents.
9. Add the contents of **one Vario Molybdenum HR 3 F10 Powder Pack** straight from the foil to the same water sample.
10. Close the vial tightly with the cap and swirl several times to mix the contents.
11. Place the vial in the sample chamber making sure that the Σ marks are aligned.
12. Press **TEST** key.
Wait for a **reaction period of 5 minutes**.

Zero accepted
prepare Test
press TEST

Countdown
5:00

After the reaction period is finished the measurement starts automatically.

The result is shown in the display in mg/l Molybdate / Molybdenum.

1.1 Methods

Notes:

1. Filter turbid water samples using filter paper and funnel before analysis.
2. Highly buffered water samples or extreme pH values should be adjusted to a pH of nearly 7 with 1 mol/l Nitric acid or 1 mol/l Sodium hydroxide.
3. Concentrations above 10 mg/l Cu causes too high test values if the reaction time of 5 minutes is increased. So it is very important to perform the test procedure as described.
4. Substances which may interfere when present in concentrations at:

Aluminium	50 mg/l
Chromium	1000 mg/l
Iron	50 mg/l
Nickel	50 mg/l
Nitrite	all levels

5. ▲ MoO₄
Mo
▼ Na₂MoO₄

Reagent / Accessories	Form of reagent/Quantity	Order-No.
Set VARIO Molybdenum HR1 F10 VARIO Molybdenum HR2 F10 VARIO Molybdenum HR3 F10	Powder Pack / 100 Powder Pack / 100 Powder Pack / 100	535300

1.1 Methods

2 5 5

Nickel with Reagent Test

0.02 – 1 mg/l Ni

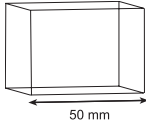

prepare Zero
press ZERO

1. Fill a clean 50 mm cell **with water sample**.
2. Place the cell in the sample chamber making sure that the positioning is correct.
3. Press **ZERO** key.
4. Remove the cell from the sample chamber. Empty the cell and dry completely.
5. Fill a beaker with **10 ml water sample**.
6. Add **2 level spoon of No. 8 (black) Nickel-51** and dissolve the reagent.
7. Add **0.2 ml Nickel-52** to the same water sample and mix.
8. Fill the 50 mm cell with the coloured test solution.
9. Place the cell in the sample chamber making sure that the positioning is correct.

Zero accepted
prepare Test
press TEST

Countdown
3:00

10. Press **TEST** key.
Wait for a **reaction period of 3 minutes**.

After the reaction period is finished the measurement starts automatically.

The result is shown in the display in mg/l Nickel.

1.1 Methods

Notes:

1. The test sample and the reagents should have room temperature for test performance.
2. The test sample should have a pH of between 3 and 9.

Reagent / Accessories	Form of reagent/Quantity	Order-No.
SET: NICKEL 51 / 52	Reagent Test / approx. 50 Tests	2419033

1.1 Methods

2

5

6

Nickel with Reagent Test

0.2 – 7 mg/l Ni



Ø 24 mm

prepare Zero
press ZERO

1. Fill a clean vial (24 mm Ø) with **3 ml of the water sample** and **7 ml of deionised water**, close tightly with the cap.
2. Place the vial in the sample chamber making sure that the Σ marks are aligned.
3. Press **ZERO** key.
4. Remove the vial from the sample chamber.
5. Add **2 level spoon of No. 8 (black) Nickel-51** into the prepared water sample.
6. Close the vial tightly with the cap and invert several times to mix the contents.
7. Add **0.2 ml Nickel-52** to the same water sample.
8. Close the vial tightly with the cap and invert several times to mix the contents.
9. Place the vial in the sample chamber making sure that the Σ marks are aligned.
10. Press **TEST** key.

Zero accepted
prepare Test
press TEST

Countdown
3:00

Wait for a **reaction period of 3 minutes**.

After the reaction period is finished the measurement starts automatically.

The result is shown in the display in mg/l Nickel.

1.1 Methods

Notes:

1. The test sample and the reagents should have room temperature for test performance.
2. The test sample should have a pH of between 3 and 9.

Reagent / Accessories	Form of reagent/Quantity	Order-No.
SET: NICKEL 51 / 52	Reagent Test / approx. 50 Tests	2419033

1.1 Methods

2 6 5

Nitrate with Tube Test

1 – 30 mg/l N



Ø 16 mm

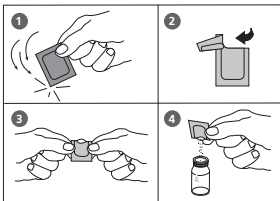

Countdown

5:00

start: ↓

prepare Zero
press ZERO

Zero accepted
prepare Test
press TEST

1. Open one white capped reaction vial (Reagent A) and add **1 ml deionised water** (this is the blank).
2. Open another white capped reaction vial (Reagent A) and add **1 ml water sample** (this is the sample).
3. Add the contents of **one Vario Nitrate Chromotropic Powder Pack** straight from the foil into each vial.
4. Close the vials tightly with the caps and invert gently several times (10 x) to mix the contents (Note 1).
5. Press **[↓]** key.
Wait for a **reaction period of 5 minutes**.
6. After the reaction period is finished proceed as follows:
7. Place the vial (the blank) in the sample chamber making sure that the marks are Δ aligned.
8. Press **ZERO** key.
9. Remove the vial from the sample chamber.
10. Place the vial (the sample) in the sample chamber making sure that the marks are Δ aligned.
11. Press **TEST** key.

The result is shown in the display in mg/l Nitrate.

1.1 Methods

Notes:

1. Some solids may not dissolve.

2. Conversion:

$$\text{mg/l NO}_3 = \text{mg/l N} \times 4.43$$

3. ▲ N
▼ NO₃

Reagent / Accessories	Form of reagent/Quantity	Order-No.
Set VARIO Nitrate Chromotropic VARIO Nitra X Reagent tube VARIO deionised water	Set Powder Pack / 50 Reaction tube / 50 100 ml	535580

1.1 Methods

2 6 7

Nitrate LR with Tube Test

0.5 – 14 mg/l N



Ø 16 mm

prepare Zero
press ZERO

1. Place the supplied blank (red label) in the sample chamber making sure that the marks Δ are aligned.
2. Press **ZERO** key.
3. Remove the vial from the sample chamber.

4. Add **0.5 ml of water sample** into one reaction tube.
5. Close the vial tightly with the cap and invert several times to mix the contents.

(Caution: tube becomes warm!)

6. Add **0.2 ml Nitrate-111**.
7. Close the vial tightly with the cap and invert several times to mix the contents.
8. Place the vial in the sample chamber making sure that the marks Δ are aligned.

Zero accepted
prepare Test
press TEST

9. Press **TEST** key.

Wait for a **reaction period of 15 minutes**.

After the reaction period is finished the measurement starts automatically.

The result is shown in the display in mg/l Nitrate.

Countdown
15:00

1.1 Methods

Notes:

1. Nitrite concentrations greater than 2 mg/L NO_2^- lead to higher test results.
2. Great quantities of COD lead to higher test results.
3. \blacktriangle N
 \blacktriangledown NO_3

Reagent / Accessories	Form of reagent/Quantity	Order-No.
Set: Reaktion tube NITRATE-111	Tube Test (Liquid reagent) / 24 Tests	2420702

1.1 Methods

2 7 0

Nitrite with Tablet

0.01 – 0.5 mg/l N



prepare Zero
press ZERO

1. Fill a clean vial (24 mm Ø) with **10 ml of the water sample**, close tightly with the cap.
2. Place the vial in the sample chamber making sure that the marks ∇ are aligned.
3. Press **ZERO** key.
4. Remove the vial from the sample chamber.
5. Add **one NITRITE LR tablet** straight from the foil to the water sample and crush the tablet using a clean stirring rod.
6. Close the vial tightly with the cap and swirl several times until the tablet is dissolved.
7. Place the vial in the sample chamber making sure that the marks ∇ are aligned.

Zero accepted
prepare Test
press TEST

Countdown
10:00

8. Press **TEST** key.
Wait for a **reaction period of 10 minutes**.

After the reaction period is finished the measurement starts automatically.

The result is shown in the display in mg/l Nitrite.

1.1 Methods

Notes:

1. The following ions can produce interferences since under the reaction conditions they cause precipitation:

Antimony (III), Iron (III), Lead, Mercury (I), Silver, Chloroplatinate, Metavanadate and Bismuth.

Copper (II)-ions may cause lower test results as they accelerate the decomposition of the Diazonium salt.

It is unlikely in practice that these interfering ions will occur in such high concentrations that they cause significant reading errors.

2. Conversion:

$$\text{mg/l NO}_2 = \text{mg/l N} \times 3.29$$

3. ▲ N
▼ NO₂

Reagent / Accessories	Form of reagent/Quantity	Order-No.
NITRITE LR	Tablet / 100	512310BT

1.1 Methods

2 7 2

Nitrite LR with Vario Powder Pack

0.01 – 0.3 mg/l N



Ø 24 mm

prepare Zero
press ZERO

1. Fill a clean vial (24 mm Ø) with **10 ml of the water sample**, close tightly with the cap.
2. Place the vial in the sample chamber making sure that the Σ marks are aligned.
3. Press **ZERO** key.
4. Remove the vial from the sample chamber.

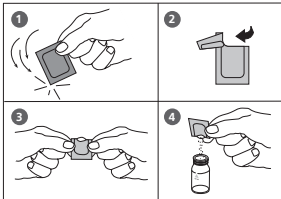

5. Add the contents of **one Vario Nitri 3 Powder Pack** straight from the foil to the water sample.
6. Close the vial tightly with the cap and swirl several times to mix the contents.
7. Place the vial in the sample chamber making sure that the Σ marks are aligned.

Zero accepted
prepare Test
press TEST

Countdown
20:00

8. Press **TEST** key.
Wait for a **reaction period of 20 minutes**.

After the reaction period is finished the measurement starts automatically.

The result is shown in the display in mg/l Nitrite.

1.1 Methods

Notes:

1. Interferences:

- Strong oxidizing and reducing substances interfere.
- Cupric and ferrous ions cause low results.
- Antimonous, Auric, Bismuth, Chloroplatinate, Ferric, Lead, Mercurous, Metavanadate, Silver ions interfere by causing precipitation.
- In samples with very high concentrations of Nitrate (> 100 mg/l N) a small amount of Nitrite will be found. Such high levels of Nitrate appear to undergo a slight amount of reduction to Nitrite, either spontaneously or during the reaction time of the test.

2. ▲ N
▼ NO₂

Reagent / Accessories	Form of reagent/Quantity	Order-No.
Vario Nitri 3 F10	Powder Pack / 100	530980

1.1 Methods

2 7 5

Nitrite, LR with Tube Test

0.03 – 0.6 mg/l N



prepare Zero
press ZERO

1. Place the supplied blank (red label) in the sample chamber making sure that the marks Δ are aligned.
2. Press **ZERO** key.
3. Remove the vial from the sample chamber.
4. Add **2 ml of water sample** into one reaction tube.
5. Close the vial tightly with the cap and invert several times to mix the contents.
6. Add **one level scoop No. 8 (black) Nitrite-101**.
7. Close the vial tightly with the cap and swirl until the reagent is dissolved completely.
8. Place the vial in the sample chamber making sure that the marks Δ are aligned.

Zero accepted
prepare Test
press TEST

Countdown
10:00

9. Press **TEST** key.

Wait for a **reaction period of 10 minutes**.

After the reaction period is finished the measurement starts automatically.

The result is shown in the display in mg/l Nitrite.

1.1 Methods

Notes:

1. Store the reagents in closed containers at a temperature of + 4°C to + 8°C.
2. The test sample and the reagents should have room temperature for test performance.

3. ▲ N
▼ NO₂

Reagent / Accessories	Form of reagent/Quantity	Order-No.
Set: Reaktion Tube NITRITE-101	Tube Test (Powder) / 24 Tests	2419018

1.1 Methods

2

7

6

Nitrite, HR with Tube Test

0.3 – 3 mg/l N



prepare Zero
press ZERO

1. Place the supplied blank (red label) in the sample chamber making sure that the marks Δ are aligned.
2. Press **ZERO** key.
3. Remove the vial from the sample chamber.
4. Add **0.5 ml of water sample** into one reaction tube.
5. Close the vial tightly with the cap and invert several times to mix the contents.
6. Add **one level scoop No. 8 (black) Nitrite-101**.
7. Close the vial tightly with the cap and swirl until the reagent is dissolved completely.
8. Place the vial in the sample chamber making sure that the marks Δ are aligned.

Zero accepted
prepare Test
press TEST

Countdown
10:00

9. Press **TEST** key.

Wait for a **reaction period of 10 minutes**.

After the reaction period is finished the measurement starts automatically.

The result is shown in the display in mg/l Nitrite.

1.1 Methods

Notes:

1. Store the reagents in closed containers at a temperature of + 4°C to + 8°C.
2. The test sample and the reagents should have room temperature for test performance.

3.  N
 NO₂

Reagent / Accessories	Form of reagent/Quantity	Order-No.
Set: Reaktion Tube NITRITE-101	Tube Test (Powder) / 24 Tests	2419018

1.1 Methods

2 8 0

Nitrogen, total LR with Vario Tube Test

0.5 – 25 mg/l N

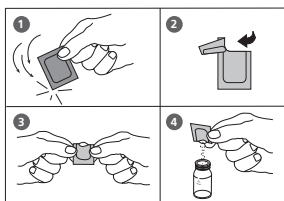

1. **Open two TN Hydroxide LR digestion vials** and add the contents of **one Vario TN Persulfate Rgt. Powder Pack** (Note 2, 3).
2. Add **2 ml deionised water** to the prepared vial (this is the blank, Note 4, 5).
3. Add **2 ml of water sample** to the other prepared vial (this is the sample).
4. Close the vials with the caps and shake to mix the contents (at least 30 seconds, Note 6).
5. Heat the vials for **30 minutes** in the preheated reactor at a temperature of **100°C** (Note 7).
6. After 30 minutes remove the vials from the reactor. **(CAUTION: The vials are hot!)**
Allow the vials to cool to room temperature.
7. Open the cooled digestion vials and add the contents of **one Vario TN Reagent A Powder Pack** to each vial (Note 2).
8. Close the vials with the caps and shake to mix the contents (at least 15 seconds).
9. Press [↵] key.
Wait for a **reaction period of 3 minutes**.
After the reaction period is finished proceed as follows:
10. Open the digestion vials and add the contents of **one Vario TN Reagent B Powder Pack** to each vial (Note 2).

Countdown
3:00
start: ↵

1.1 Methods

Countdown

2:00

start: ↵

11. Close the vials with the caps and shake to mix the contents (at least 15 seconds, Note 8).

12. Press **[↵]** key.

Wait for a **reaction period of 2 minutes**.

After the reaction period is finished proceed as follows:

13. Open **two TN Acid LR/HR (Reagent C) vials** and add **2 ml of the digested, treated blank** to one vial (this is the blank).

14. Add **2 ml of the digested, treated water sample** to the other TN Acid LR/HR vial (this is the sample).

15. Close the vials with the caps and swirl the vials gently several times to mix the contents (10 x, Note 9).
(CAUTION: Vials warm up).

16. Place the vial (the blank) in the sample chamber making sure that the marks  are aligned.

prepare Zero

press ZERO

17. Press **ZERO** key.

Wait for a **reaction period of 5 minutes**.

After the reaction period is finished the measurement starts automatically.

Countdown

5:00

18. Remove the vial from the sample chamber.

19. Place the vial (the sample, Note 10) in the sample chamber making sure that the marks  are aligned.

Zero accepted

prepare Test

press TEST

20. Press **TEST** key.

The result is shown in the display in mg/l Nitrogen.

Notes and Reagent: see page 204

1.1 Methods

2 8 1

Nitrogen, total HR with Vario Tube Test

5 – 150 mg/l N

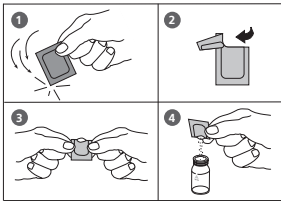

1. **Open two TN Hydroxide HR digestion vials** and add the contents of **one Vario TN Persulfate Rgt. Powder Pack** (Note 2, 3).
2. Add **0.5 ml deionised water** to the prepared vial (this is the blank, Note 4, 5).
3. Add **0.5 ml of water sample** to the other prepared vial (this is the sample).
4. Close the vials with the caps and shake to mix the contents (at least 30 seconds, Note 6).
5. Heat the vials for **30 minutes** in the preheated reactor at a temperature of **100°C** (Note 7).
6. After 30 minutes remove the vials from the reactor. **(CAUTION: The vials are hot!)** Allow the vials to cool to room temperature.
7. Open the cooled digestion vials and add the contents of **one Vario TN Reagent A Powder Pack** to each vial (Note 2).
8. Close the vials with the caps and shake to mix the contents (at least 15 seconds).
9. Press **[↵]** key.
Wait for a **reaction period of 3 minutes**. After reaction period is finished proceed as follows:
10. Open the digestion vials and add the contents of **one Vario TN Reagent B Powder Pack** to each vial (Note 2).

Countdown
3:00
start: ↵

1.1 Methods

Countdown
2:00
start: ↵

11. Close the vials with the caps and shake to mix the contents (at least 15 seconds, Note 8).

12. Press **[↵]** key.
Wait for a **reaction period of 2 minutes**.
After the reaction period is finished proceed as follows:

13. Open **two TN Acid LR/HR (Reagent C) vials** and add **2 ml of the digested, treated blank** to one vial (this is the blank).

14. Add **2 ml of the digested, treated water sample** to the other TN Acid LR/HR vial (this is the sample).

15. Close the vials with the caps and swirl the vials gently several times to mix the contents (10 x, Note 9).
(CAUTION: Vials warm up)

16. Place the vial (the blank) in the sample chamber making sure that the **Δ** marks are aligned.

prepare Zero
press ZERO

Countdown
5:00

17. Press **ZERO** key.
Wait for a **reaction period of 5 minutes**.
After the reaction period is finished the measurement starts automatically.

18. Remove the vial from the sample chamber.

19. Place the vial (the sample, Note 10) in the sample chamber making sure that the **Δ** marks are aligned.

Zero accepted
prepare Test
press TEST

20. Press **TEST** key.
The result is shown in the display in mg/l Nitrogen.

Notes and Reagent: see page 204

1.1 Methods

Notes:

1. Appropriate safety precautions and a good lab technique should be used during the whole procedure.
2. Use a funnel to add the reagent.
3. Wipe off any Persulfate reagent that may get on the lid or the tube threads.
4. Nitrogen, total LR:
Volumes for samples and blank should always be metered by using 2 ml volumetric pipettes (class A).
Nitrogen, total HR:
Volumes for samples and blank should always be metered by using suitable pipettes (class A).
5. One blank is sufficient for each set of samples.
6. The reagent may not dissolve completely.
7. It is very important to remove the vials from the reactor after exactly 30 minutes.
8. The reagent will not completely dissolve.
9. Hold the vial in a vertical position with the cap pointing up. Turn the vial upside-down. Wait for all of the solution to flow down to the cap. Return the vial to the upright position. Wait for all the solution to flow to the bottom of the vial. This process is one inversion; 10 inversions = approx. 30 seconds.
10. The zero (stored in the dark) can be used for 7 days, if the measured samples were prepared with the same batch of reagent.
11. Large quantities of nitrogen free, organic compounds which are included in some water samples may reduce the effectiveness of the digestion by reacting with the Persulfate reagent. Samples which are well known to contain large quantities of organic compounds must be diluted and digestion and measurement must be repeated for checking the effectiveness of the digestion.
12. Application: for water, wastewater and seawater
13. Interferences:
Interfering substances that resulted in a concentration change of 10%:
Bromide more than 60 mg/l and Chloride more than 1000 mg/l produce positive interferences.
TN = Total Nitrogen
14. ▲ N
 NH₄
 ▼ NH₃

1.1 Methods

Nitrogen, total LR with Vario Tube Test

Reagent / Accessories	Form of reagent/Quantity	Order-No.
Tube test contains: VARIO TN HYDROX LR Tube VARIO PERSULFATE Reagent VARIO TN Reagent A VARIO TN Reagent B VARIO TN ACID LR/HR Tube VARIO deionised water	Set Digestion tube / 50 Powder Pack / 50 Powder Pack / 50 Powder Pack / 50 Reaction tube / 50 100 ml	535550

Nitrogen, total HR with Vario Tube Test

Reagent / Accessories	Form of reagent/Quantity	Order-No.
Tube test contains: VARIO TN HYDROX HR Tube VARIO PERSULFATE Reagent VARIO TN Reagent A VARIO TN Reagent B VARIO TN ACID LR/HR Tube VARIO deionised water	Set Digestion tube / 50 Powder Pack / 50 Powder Pack / 50 Powder Pack / 50 Reaction tube / 50 100 ml	535560

1.1 Methods



Nitrogen, total LR 2 with Tube Test

0.5 – 14 mg/l N



Digestion:

1. Fill one of the supplied digestion vials with **5 ml of the water sample**.
2. Add **1 level scoop No. 8 (black) digestion reagent**.
3. Close the vial tightly with the cap and invert several times to mix the contents.
4. Heat the vial for **60 minutes** in a preheated thermo-reactor at a temperature of **100°C**.
5. Remove the vial from the thermoreactor.
(CAUTION: The vials are hot!).
Invert the vial and allow to cool to room temperature.
6. Add **1 level scoop No. 4 (white) compensation reagent**.
7. Close the vial tightly with the cap and invert several times to mix the contents.
8. Use this pre-treated sample for the following test procedure:

Performing test procedure:

9. Place the supplied blank (red label) in the sample chamber making sure that the marks  are aligned.
10. Press **ZERO** key.
11. Remove the vial from the sample chamber.
12. Open **one reagent tube** and add **0.5 ml of the pre-treated sample** (step 8).
13. Close the vial tightly with the cap and invert several times to mix the contents.
(Caution: Vial becomes warm!)

prepare Zero
press ZERO

1.1 Methods

14. **Add 0.2 ml Nitrate-111.**
15. Close the vial tightly with the cap and invert several times to mix the contents.
16. Place the vial in the sample chamber making sure that the marks Δ are aligned.
17. Press **TEST** key.
Wait for a **reaction period of 15 minutes**.

**Zero accepted
prepare Test
press TEST**

**Countdown
15:00**

After the reaction period is finished the measurement starts automatically.

The result is shown in the display in mg/l total Nitrogen.

Notes:

1. This test determines the inorganic compounds Ammonia, Nitrate and Nitrite, as well as organic compounds like amino acid, urea, complexing agents etc.
2. Nitrogen compounds which are hard to oxidise, as may be found in industrial sewage, are not digested or only partially.
3. \blacktriangle N
 NH_4
 \blacktriangledown NH_3

Reagent / Accessories	Form of reagent/Quantity	Order-No.
SET: Digestion reagent Compensation reagent Nitrate-111	Tube test (powder, liquid reagent) / 24 Tests	2420703

1.1 Methods



Nitrogen, total HR 2 with Tube Test

5 – 140 mg/l N



Digestion:

1. Fill one of the supplied digestion vials with **0.5 ml of the water sample** and **4.5 ml deionised water**.
2. Add **1 level scoop No. 8 (black) digestion reagent**.
3. Close the vial tightly with the cap and invert several times to mix the contents.
4. Heat the vial for **60 minutes** in a preheated thermo-reactor at a temperature of **100°C**.
5. Remove the vial from the thermoreactor.
(CAUTION: The vials are hot!).
Invert the vial and allow to cool to room temperature.
6. Add **1 level scoop No. 4 (white) compensation reagent**.
7. Close the vial tightly with the cap and invert several times to mix the contents.
8. Use this pre-treated sample for the following test procedure:

Performing test procedure:

9. Place the supplied blank (red label) in the sample chamber making sure that the marks  are aligned.
10. Press **ZERO** key.
11. Remove the vial from the sample chamber.
12. Open **one reagent tube** and add **0.5 ml of the pre-treated sample** (step 8).
13. Close the vial tightly with the cap and invert several times to mix the contents.
(Caution: Vial becomes warm!)

prepare Zero
press ZERO

1.1 Methods

14. Add 0.2 ml Nitrate-111.

15. Close the vial tightly with the cap and invert several times to mix the contents.

16. Place the vial in the sample chamber making sure that the marks Δ are aligned.

Zero accepted
prepare Test
press TEST

Countdown
15:00

17. Press **TEST** key.

Wait for a **reaction period of 15 minutes**.

After the reaction period is finished the measurement starts automatically.

The result is shown in the display in mg/l total Nitrogen.

Notes:

1. This test determines the inorganic compounds Ammonia, Nitrate and Nitrite, as well as organic compounds like amino acid, urea, complexing agents etc.
2. Nitrogen compounds which are hardly to oxidise, as may be found in industrial sewage, are not digested or only partially.
3. \blacktriangle N
 NH_4
 \blacktriangledown NH_3

Reagent / Accessories	Form of reagent/Quantity	Order-No.
SET: Digestion reagent Compensation reagent Nitrate-111	Tube test (powder, liquid reagent) / 24 Tests	2420703

1.1 Methods

2 9 0

Oxygen, active * with Tablet

0.1 – 10 mg/l O₂



prepare Zero
press ZERO

1. Fill a clean vial (24 mm Ø) with **10 ml of the water sample**, close tightly with the cap.
2. Place the vial in the sample chamber making sure that the Σ marks are aligned.
3. Press **ZERO** key.
4. Remove the vial from the sample chamber.
5. Add **one DPD No. 4 tablet** straight from the foil to the water sample and crush the tablet using a clean stirring rod.
6. Close the vial tightly with the cap and swirl several times until the tablet is dissolved.
7. Place the vial in the sample chamber making sure that the Σ marks are aligned.
8. Press **TEST** key.

Wait for a **reaction period of 2 minutes**.

After the reaction period is finished the measurement starts automatically.

The result is shown in the display in mg/l active Oxygen.

Zero accepted
prepare Test
press TEST

Countdown
2:00

1.1 Methods

Notes:

*** Active Oxygen is a synonym for a common disinfectant (based on "Oxygen") in Swimming Pool Treatment.**

1. When preparing the sample, the loss of Oxygen gases, e.g. by pipetting or shaking, must be avoided.
2. The analysis must take place immediately after taking the sample.

Reagent / Accessories	Form of reagent/Quantity	Order-No.
DPD No. 4	Tablet / 100	511220BT

1.1 Methods

2 9 9

Ozone with Tablet

0.02 – 0.5 mg/l O₃

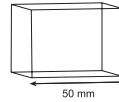

3 0 0

Ozone with Tablet

0.02 – 1 mg/l O₃



Ozon

>>

with Cl
without Cl

The following selection is shown in the display:

>>

with Cl

for the determination of Ozone in the presence of Chlorine.

>>

without Cl

for the determination of Ozone in the absence of Chlorine.

Select the desired method with the arrow keys [▲] and [▼].
Confirm with [↵] key.

1.1 Methods

Notes:

1. Vial cleaning:
As many household cleaners (e.g. dishwasher detergent) contain reducing substances, the subsequent determination of Ozone may show lower results. To avoid any measurement errors, only use glassware free of Chlorine demand.
Preparation: Put all applicable glassware into Sodium hypochlorite solution (0.1 g/l) for one hour, then rinse all glassware thoroughly with deionised water.
2. Preparing the sample:
When preparing the sample, the loss of Ozone, e.g. by pipetting or shaking, must be avoided. The analysis must take place immediately after taking the sample.
3. The DPD colour development is carried out at a pH value of 6.2 to 6.5. The reagent tablet therefore contains a buffer for the pH adjustment.
Strong alkaline or acidic water samples must be adjusted between pH 6 and pH 7 before the tablet is added (use 0.5 mol/l Sulfuric acid resp. 1 mol/l Sodium hydroxide).
4. Exceeding the measuring range:
Concentrations above 6 mg/l Ozone can lead to results showing 0 mg/l. In this case, the water sample must be diluted with water free of Ozone. 10 ml of the diluted sample should be mixed with the reagent and the measurement repeated.
5. If **???** is displayed at the differentiated test result see page 356.
6. Oxidising agents such as Bromine, Chlorine etc. interfere as they react in the same way as Ozone.

1.1 Methods



Ozone, in the presence of Chlorine with Tablet

0.02 – 0.5 mg/l O₃

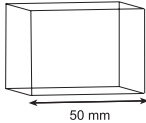

prepare Zero
press ZERO

1. Fill a clean 50 mm cell with **water sample**.
2. Place the cell in the sample chamber making sure that the positioning is correct.
3. Press **ZERO** key.
4. Remove the cell from the sample chamber. Empty the cell and dry completely.
5. Rinse a beaker with the water sample and **empty it, leaving a few drops remaining in the beaker**.
6. Add **one DPD No. 1 tablet** and **one DPD No. 3 tablet** straight from the foil and crush the tablet using a clean stirring rod.
7. Add **10 ml water sample** and dissolve the tablets.
8. Fill the 50 mm cell with the coloured test solution.
9. Place the cell in the sample chamber making sure that the positioning is correct.
10. Press **TEST** key.

Zero accepted
prepare T1
press TEST

Countdown
2:00

Wait for a **reaction period of 2 minutes**.

After the reaction period is finished the measurement starts automatically.

11. Remove the cell from the sample chamber. Empty the cell and dry completely.
12. Fill a beaker with **10 ml water sample**.
13. Add **one Glycine tablet** straight from the foil and crush the tablet using a clean stirring rod. Dissolve the tablet.
14. **Rinse a second beaker with the sample and empty the beaker**.

1.1 Methods

15. Add **one DPD No. 1 tablet** and **one DPD No. 3 tablet** straight from the foil and crush the tablet using a clean stirring rod.
16. **Transfer the contents of the first beaker (Glycine solution) into the prepared beaker (point 15). Dissolve the tablets.**
17. Fill the 50 mm cell with the coloured test solution.
18. Place the cell in the sample chamber making sure that the positioning is correct.
19. Press **TEST** key.

Wait for a **reaction period of 2 minutes**.

After the reaction period is finished the measurement starts automatically.

The result is shown in the display in:

**T1 accepted
prepare T2
press TEST**

**Countdown
2:00**

***,** mg/l O₃
*,** mg/l tot Cl**

mg/l Ozone
mg/l total Chlorine

Notes: see page 213

Reagent / Accessories	Form of reagent/Quantity	Order-No.
Set DPD No. 1 / No. 3	Tablet / per 100 inclusive stirring rod	517711BT
DPD No. 1	Tablet / 100	511050BT
DPD No. 3	Tablet / 100	511080BT
GLYCINE	Tablet / 100	512170BT

1.1 Methods



Ozone, in absence of Chlorine with Tablet

0.02 – 0.5 mg/l O₃

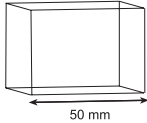

prepare Zero
press ZERO

1. Fill a clean 50 mm cell with **water sample**.
2. Place the cell in the sample chamber making sure that the positioning is correct.
3. Press **ZERO** key.
4. Remove the cell from the sample chamber. Empty the cell and dry completely.
5. Rinse a beaker with the water sample and **empty it, leaving a few drops remaining in the beaker**.
6. Add **one DPD No. 1 tablet** and **one DPD No. 3 tablet** straight from the foil and crush the tablet using a clean stirring rod.
7. Add **10 ml water sample** and dissolve the tablets.
8. Fill the 50 mm cell with the coloured test solution.
9. Place the cell in the sample chamber making sure that the positioning is correct.

Zero accepted
prepare Test
press TEST

Countdown
2:00

10. Press **TEST** key.

Wait for a **reaction period of 2 minutes**.

After the reaction period is finished the measurement starts automatically.

The result is shown in the display in mg/l Ozone.

1.1 Methods

Notes: see page 213

Reagent / Accessories	Form of reagent/Quantity	Order-No.
Set DPD No. 1 / No. 3	Tablet / per 100 inclusive stirring rod	517711BT
DPD No. 1	Tablet / 100	511050BT
DPD No. 3	Tablet / 100	511080BT

1.1 Methods

3 0 0

Ozone, in the presence of Chlorine with Tablet

0.02 – 1 mg/l O₃



prepare Zero
press ZERO

1. Fill a clean vial (24 mm Ø) with **10 ml of the water sample**, close tightly with the cap.
2. Place the vial in the sample chamber making sure that the Σ marks are aligned.
3. Press **ZERO** key.
4. Remove the vial from the sample chamber and **empty it, leaving a few drops remaining in the vial.**
5. Add **one DPD No. 1 tablet** and **one DPD No. 3 tablet** straight from the foil and crush the tablets using a clean stirring rod.
6. Add water sample to the 10 ml mark.
7. Close the vial tightly with the cap and swirl several times until the tablets are dissolved.
8. Place the vial in the sample chamber making sure that the Σ marks are aligned.

Zero accepted
prepare T1
press TEST

Countdown
2:00

9. Press **TEST** key.
Wait for a **reaction period of 2 minutes.**
After the reaction period is finished the measurement starts automatically.
10. Remove the vial from the sample chamber, empty the vial, rinse vial and cap several times.
11. **Fill a second clean vial with 10 ml of water sample.**
12. Add **one GLYCINE tablet** straight from the foil and crush the tablet using a clean stirring rod.

1.1 Methods

13. Close the vial tightly with the cap and swirl several times until the tablet is dissolved.
14. Add **one DPD No. 1 tablet** and **one DPD No. 3 tablet** straight from the foil into the first cleaned vial and crush the tablets using a clean stirring rod.
15. **Transfer the contents of the second vial (Glycine solution) into the prepared vial (point 14).**
16. Close the vial tightly with the cap and swirl several times until the tablets are dissolved.
17. Place the vial in the sample chamber making sure that the Σ marks are aligned.
18. Press **TEST** key.

T1 accepted
prepare T2
press TEST

Countdown
2:00

Wait for a **reaction period of 2 minutes**.

After the reaction period is finished the measurement starts automatically.

The result is shown in the display in:

*,** mg/l O₃
*,** mg/l total Cl

mg/l Ozone
mg/l total Chlorine

Notes: see page 213

Reagent / Accessories	Form of reagent/Quantity	Order-No.
Set DPD No. 1 / No. 3	Tablet / per 100 inclusive stirring rod	517711BT
DPD No. 1	Tablet / 100	511050BT
DPD No. 3	Tablet / 100	511080BT
GLYCINE	Tablet / 100	512170BT

1.1 Methods

3 0 0

Ozone, in absence of Chlorine with Tablet

0.02 – 1 mg/l O₃



prepare Zero
press ZERO

1. Fill a clean vial (24 mm Ø) **with 10 ml of the water sample**, close tightly with the cap.
2. Place the vial in the sample chamber making sure that the Σ marks are aligned.
3. Press **ZERO** key.
4. Remove the vial from the sample chamber and **empty it, leaving a few drops remaining in the vial**.
5. Add **one DPD No. 1 tablet** and **one DPD No. 3 tablet** straight from the foil and crush the tablets using a clean stirring rod.
6. Add water sample to the 10 ml mark.
7. Close the vial tightly with the cap and swirl several times until the tablets are dissolved.
8. Place the vial in the sample chamber making sure that the Σ marks are aligned.
9. Press **TEST** key.

Wait for a **reaction period of 2 minutes**.

After the reaction period is finished the measurement starts automatically.

The result is shown in the display in mg/l Ozone.

Zero accepted
prepare Test
press TEST

Countdown
2:00

1.1 Methods

Notes: See page 213

Reagent / Accessories	Form of reagent/Quantity	Order-No.
Set DPD No. 1 / No. 3	Tablet / per 100 inclusive stirring rod	517711BT
DPD No. 1	Tablet / 100	511050BT
DPD No. 3	Tablet / 100	511080BT

1.1 Methods



pH value 6.5 – 8.4 with Tablet



1. Fill a clean vial (24 mm Ø) with **10 ml of the water sample**, close tightly with the cap.
2. Place the vial in the sample chamber making sure that the Σ marks are aligned.
3. Press **ZERO** key.
4. Remove the vial from the sample chamber.
5. Add **one PHENOL RED PHOTOMETER tablet** straight from the foil to the water sample and crush the tablet using a clean stirring rod.
6. Close the vial tightly with the cap and swirl several times until the tablet is dissolved.
7. Place the vial in the sample chamber making sure that the Σ marks are aligned.
8. Press **TEST** key.

prepare Zero
press ZERO

Zero accepted
prepare Test
press TEST

The result is shown in the display as pH-value.

1.1 Methods

Notes:

1. For photometric determination of pH-values only use PHENOL RED tablets in black printed foil pack and marked with PHOTOMETER.
2. Water samples with low values of Alkalinity-m (below 35 mg/l CaCO₃) may give wrong pH readings.
3. pH-values below 6.5 and above 8.4 can produce results inside the measuring range. A plausibility test (pH-meter) is recommended.
4. Salt error

For salt concentrations below 2 g/l no significant error, due to the salt concentration of the reagent tablet, is expected. For higher salt concentrations the measurement values have to be adjusted as follows:

Salt content	30 g/l (seawater)	60 g/l	120 g/l	180 g/l
Correction	- 0,15 ¹⁾	- 0,21 ²⁾	- 0,26 ²⁾	- 0,29 ²⁾

¹⁾ according to Kolthoff (1922)

²⁾ according to Parson und Douglas (1926)

Reagent / Accessories	Form of reagent/Quantity	Order-No.
PHENOL RED PHOTOMETER	Tablet / 100	511770BT

1.1 Methods



pH value 6.5 – 8.4 with Liquid Reagent



Ø 24 mm

prepare Zero
press ZERO

1. Fill a clean vial (24 mm Ø) with **10 ml of the water sample**, close tightly with the cap.
2. Place the vial in the sample chamber making sure that the Σ marks are aligned.
3. Press **ZERO** key.
4. Remove the vial from the sample chamber.
5. Fill the vial with drops of the same size by holding the bottle vertically and squeeze slowly:

6 drops of PHENOL RED solution

6. Close the vial tightly with the cap and swirl several times to mix the contents.
7. Place the vial in the sample chamber making sure that the Σ marks are aligned.
8. Press **TEST** key.

Zero accepted
prepare TEST
press Test

The result is shown in the display as pH-value.

1.1 Methods

Notes:

1. When testing chlorinated water the residual chlorine contents can influence the colour reaction of the liquid reagent. This can be avoided (without interfering with the pH measurement) by adding a small crystal of Sodiumthiosulfate ($\text{Na}_2\text{S}_2\text{O}_3 \cdot 5 \text{H}_2\text{O}$) to the sample before adding the PHENOL RED solution. PHENOL RED tablets already contain Thiosulfate.
2. Due to differing drop sizes results can show a discrepancy in accuracy by comparison with tablets. This can be minimised by using a pipette (0.18 ml PHENOL RED solution is equivalent to 6 drops).
3. After use replace the bottle cap securely.
- 4. Store the reagent in a cool, dry place ideally between 6°C and 10°C.**

5. Salt error

For higher salt concentrations the measurement values have to be adjusted as follows:

Salt content	30 g/l (seawater)	60 g/l	120 g/l	180 g/l
Correction	- 0,15 ¹⁾	- 0,21 ²⁾	- 0,26 ²⁾	- 0,29 ²⁾

¹⁾ according to Kolthoff (1922)

²⁾ according to Parson und Douglas (1926)

Reagent / Accessories	Form of reagent/Quantity	Order-No.
PHENOL RED solution	Liquid reagent / 15 ml	471040

1.1 Methods

3 1 5

Phenol with Tablet

0.1 – 5 mg/l C₆H₅OH



Ø 24 mm

prepare Zero
press ZERO

1. Fill a clean vial (24 mm Ø) with **10 ml of the water sample**, close tightly with the cap.
2. Place the vial in the sample chamber making sure that the Σ marks are aligned.
3. Press **ZERO** key.
4. Remove the vial from the sample chamber.
5. Add **one PHENOLE No. 1 tablet** straight from the foil to the water sample and crush the tablet using a clean stirring rod.
6. Add **one PHENOLE No. 2 tablet** straight from the foil to the same water sample and crush the tablet using a clean stirring rod.
7. Close the vial tightly with the cap and swirl several times until the tablets are dissolved.
8. Place the vial in the sample chamber making sure that the Σ marks are aligned.

Zero accepted
prepare Test
press TEST

Countdown
5:00

9. Press **TEST** key.
Wait for a **reaction period of 5 minutes**.

After the reaction period is finished the measurement starts automatically.

The result is shown in the display in mg/l Phenol.

1.1 Methods

Notes:

1. This method determines ortho- and meta-substituted phenols but not para-substituted phenols (see: "Standard Methods for Examination of Water and Wastewater, 20th Edition, 5-40 f."). Because water samples can contain different types of phenolic compounds, the result is displayed as the equivalent concentration of Phenol (C₆H₅OH).
2. The test sample should have a pH of between 3 and 11.
3. Interferences can be caused in the presence of reducing agents, oxidising reagents, sulphides or suspended solids. Distillation of the sample is necessary then (see: "Standard Methods for Examination of Water and Wastewater, 20th Edition, 5-40 f.").
4. Wastewater and seawater samples may also require a distillation.

Reagent / Accessories	Form of reagent/Quantity	Order-No.
PHENOLE No. 1	Tablet / 100	515950
PHENOLE No. 2	Tablet / 100	515960BT

1.1 Methods

3 2 6 Phosphate, total
with Vario Tube Test, 0.02 – 1.1 mg/l P
Determination of ortho-Phosphate ions + condensed inorganic Phosphates + organically combined Phosphates

3 1 7 Phosphate, total LR
with Tube Test, 0.07 – 3 mg/l P
Determination of ortho-Phosphate ions + condensed inorganic Phosphates + organically combined Phosphates

3 1 8 Phosphate, total HR
with Tube Test, 1.5 – 20 mg/l P
Determination of ortho-Phosphate ions + condensed inorganic Phosphates + organically combined Phosphates

3 2 0 Phosphate, ortho LR
with Tablet, 0.05 – 4 mg/l PO₄
Determination of ortho-Phosphate ions

3 2 1 Phosphate, ortho HR
with Tablet, 1 – 80 mg/l PO₄
Determination of ortho-Phosphate ions

3 2 3 Phosphate, ortho
with Vario Powder Pack, 0.06 – 2.5 mg/l PO₄
Determination of ortho-Phosphate ions

3 2 4 Phosphate, ortho
with Vario Tube Test, 0.06 – 5 mg/l PO₄
Determination of ortho-Phosphate ions

3 2 2 Phosphate, ortho (Vanadat-Molybdat)
with Tube Test, 3 – 60 mg/l PO₄
Determination of ortho-Phosphate ions

3 2 5 Phosphate, acid hydrolyzable
with Vario Tube Test, 0.02 – 1.6 mg/l P
Determination of ortho-Phosphate ions + condensed inorganic Phosphates

More information you can find in the notes according to the methods.

1.1 Methods

General:

Ortho-Phosphate ions react with the reagent to form an intense blue colour (methods **317**, **318**, **320**, **323**, **324**, **325**, **326**).

Phosphate in organic and condensed inorganic forms (meta-, pyro- and polyphosphates) must be converted to ortho-Phosphate ions before analysis.

Pretreatment of the sample with acid and heat provides the conditions for hydrolysis of the condensed inorganic forms. Organically combined phosphates are converted to ortho Phosphate ions by heating with acid and persulfate.

The amount of organically combined phosphates can be calculated:

mg/l Phosphate, organic = mg/l Phosphate, total – mg/l Phosphate, acid hydrolysable

In method **321** and **322** the ortho-Phosphate ions react with the Vanadate-molybdate-reagent under acid conditions to form a yellow coloured product.

Notes – only for tube tests and tests with Vario Powder Packs: **323, 324, 325, 326**

1. Application: for water, wastewater and seawater.
2. Highly buffered samples or samples with extreme pH values should be adjusted between pH 6 and pH 7 before analysis (with 1 mol/l Hydrochloric acid or 1 mol/l Sodium hydroxide).
3. Interferences:
Large amounts of turbidity may cause inconsistent results.

Interfering substance

Aluminium

Arsenate

Chromium

Copper

Iron

Nickel

Silica (Silicium dioxide)

Silicate

Sulfide

Zinc

Interference level:

greater than 200 mg/l

at any level

greater than 100 mg/l

greater than 10 mg/l

greater than 100 mg/l

greater than 300 mg/l

greater than 50 mg/l

greater than 10 mg/l

at any level

greater than 80 mg/l

Phosphate, ortho \triangleq Phosphorus, reactive

1.1 Methods

3 2 6



Phosphate, total with Vario Tube Test

0.02 – 1.1 mg/l P

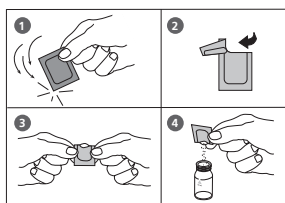

Ø 16 mm



1. Open **one white capped digestion tube PO4-P Acid reagent** and add **5 ml of water sample**.
2. Add the contents of **one Vario Potassium Persulfate F10 Powder Pack** straight from the foil to the vial (Note 2).
3. Close the vial tightly with the cap and invert several times to mix the contents.
4. Heat the vials for **30 minutes** in the preheated reactor at a temperature of **100°C**.
5. After 30 minutes remove the vial from the reactor. **(CAUTION: The vials are hot!)** Allow the vials to cool to room temperature.
6. Open the cooled digestion vial and add **2 ml 1.54 N Sodium hydroxide solution** to the vial.
7. Close the vial with the cap and invert the vial gently several times to mix the contents.
8. Place the vial in the sample chamber making sure that the marks  are aligned.
9. Press **ZERO** key.
10. Remove the vial from the sample chamber.
11. Add the contents of **one Vario Phosphate Rgt. F10 Powder Pack** straight from the foil to the vial (Note 2).
12. Close the vial tightly with the cap and swirl several times to mix the contents (approx. 10-15 sec., Note 3).
13. Place the vial in the sample chamber making sure that the marks  are aligned.
14. Press **TEST** key.

prepare Zero
press ZERO

Zero accepted
prepare Test
press TEST

Countdown
2:00

Wait for a **reaction period of 2 minutes**.

After the reaction period is finished the measurement starts automatically.

The result is shown in the display in mg/l total Phosphate.

1.1 Methods

Notes:

1. Appropriate safety precautions and a good lab technique should be used during the whole procedure.
2. Use a funnel to add the reagent.
3. The reagent does not dissolve completely.
4. See also page 229.
5. Conversions:
 $\text{mg/l PO}_4 = \text{mg/l P} \times 3.07$
 $\text{mg/l P}_2\text{O}_5 = \text{mg/l P} \times 2.29$
6. ▲ P
 PO_4
 ▼ P_2O_5

Reagent / Accessories	Form of reagent/Quantity	Order-No.
Tube test contains: VARIO Acid Reagent Vial VARIO PHOSPHATE RGT F10 PP VARIO Potassium F10 Persulfate VARIO Sodium Hydroxide 1,54 N VARIO deionised water	Set Reaction tube / 50 Powder Pack / 50 Powder Pack / 50 Solution / 100 ml 100 ml	535210

1.1 Methods



Phosphat, total LR with Tube Test

0.07 – 3 mg/l P



Digestion:

1. Add **5 ml of water sample** into one reaction tube.
2. Add **one level scoop No. 4 (white) Phosphat-103**. (Close reagent bottle immediately!)
3. Close the vial tightly with the cap and invert several times to mix the contents.
4. Heat the vial for **30 minutes** in a preheated thermo-reactor at a temperature of **100°C**.
5. Remove the vial from the thermoreactor.
(CAUTION: The vials are hot!).
Invert the vial and allow to cool to room temperature.

Performing test procedure:

6. Place the supplied blank (red label) in the sample chamber making sure that the marks Δ are aligned.
7. Press **ZERO** key.
8. Remove the vial from the sample chamber.
9. Add **2 drops (0.1 ml) Phosphate-101** into the prepared sample (see step 5).
10. Close the vial tightly with the cap and invert several times to mix the contents.
11. Add **one level scoop No. 4 (white) Phosphate-102**.
12. Close the vial tightly with the cap and swirl until the reagent is dissolved completely.
13. Place the vial in the sample chamber making sure that the marks Δ are aligned.
14. Press **TEST** key.

Wait for a **reaction period of 10 minutes**.

After the reaction period is finished the measurement starts automatically.

The result is shown in the display in mg/l total Phosphate.

prepare Zero
press ZERO

Zero accepted
prepare Test
press TEST

Countdown
10:00

1.1 Methods

Notes:

1. If the analysis is performed without digestion only ortho-Phosphate ions are determined.
2. See also page 229.

3. ▲ P



Reagent / Accessories	Form of reagent/Quantity	Order-No.
SET: Reaction tube Phosphate-103 Phosphate-101 Phosphate-102	Tube test (powder, liquid reagent) / 24 Tests	2419019

1.1 Methods



Phosphate, total HR with Tube Test

1.5 – 20 mg/l P



Digestion:

1. Add **1 ml of water sample** into one reaction tube.
2. Add **one level scoop No. 4 (white) Phosphat-103**.
(Close reagent bottle immediately!)
3. Close the vial tightly with the cap and invert several times to mix the contents.
4. Heat the vial for **30 minutes** in a preheated thermo-reactor at a temperature of **100°C**.
5. Remove the vial from the thermoreactor.
(CAUTION: The vials are hot!).
Invert the vial and allow to cool to room temperature.

Performing test procedure:

6. Place the supplied blank (red label) in the sample chamber making sure that the marks Δ are aligned.
7. Press **ZERO** key.
8. Remove the vial from the sample chamber.
9. Add **2 drops (0.1 ml) Phosphate-101** into the prepared sample (see step 5).
10. Close the vial tightly with the cap and invert several times to mix the contents.
11. Add **one level scoop No. 4 (white) Phosphate-102**.
12. Close the vial tightly with the cap and swirl until the reagent is dissolved completely.
13. Place the vial in the sample chamber making sure that the marks Δ are aligned.
14. Press **TEST** key.
Wait for a **reaction period of 10 minutes**.

After the reaction period is finished the measurement starts automatically.

The result is shown in the display in mg/l total Phosphate.

prepare Zero
press ZERO

Zero accepted
prepare Test
press TEST

Countdown
10:00

1.1 Methods

Notes:

1. If the analysis is performed without digestion only ortho-Phosphate ions are determined.
2. See also page 229.
3. ▲ P
PO₄
▼ P₂O₅

Reagent / Accessories	Form of reagent/Quantity	Order-No.
SET: Reaction tube Phosphate-103 Phosphate-101 Phosphate-102	Tube test (powder, liquid reagent) / 24 Tests	2420700

1.1 Methods



Phosphate, ortho LR with Tablet

0.05 – 4 mg/l PO₄



Ø 24 mm

prepare Zero
press ZERO

1. Fill a clean vial (24 mm Ø) with **10 ml of the water sample**, close tightly with the cap.
2. Place the vial in the sample chamber making sure that the marks  are aligned.
3. Press **ZERO** key.

4. Remove the vial from the sample chamber.
5. Add **one PHOSPHATE No. 1 LR tablet** straight from the foil to the water sample and crush the tablet using a clean stirring rod.
6. Add **one PHOSPHATE No. 2 LR tablet** straight from the foil to the same water sample and crush the tablet using a clean stirring rod.
7. Close the vial tightly with the cap and swirl several times until the tablet is dissolved.
8. Place the vial in the sample chamber making sure that the marks  are aligned.
9. Press **TEST** key.

Zero accepted
prepare Test
press TEST

Countdown
10:00

Wait for a **reaction period of 10 minutes**.

After the reaction period is finished the measurement starts automatically.

The result is shown in the display in mg/l ortho-Phosphate.

1.1 Methods

Notes:

1. Only ortho-Phosphate ions react.
2. The tablets must be added in the correct sequence.
3. The test sample should have a pH value between 6 and 7.
4. Interferences:
Higher concentrations of Cu, Ni, Cr (III), V (V) and W (VI) interfere due to their colour.
Silicates do not interfere (masked by Citric acid in the tablets).
5. See also page 229.
6. Conversion:
 $\text{mg/l P} = \text{mg/l PO}_4 \times 0.33$
 $\text{mg/l P}_2\text{O}_5 = \text{mg/l PO}_4 \times 0.75$
7. ▲ PO_4
P
▼ P_2O_5

Reagent / Accessories	Form of reagent/Quantity	Order-No.
Set PHOSPHATE LR No. 1 / No. 2	Tablet / per 100 inclusive stirring rod	517651BT
PHOSPHATE LR No. 1	Tablet / 100	513040BT
PHOSPHATE LR No. 2	Tablet / 100	513050BT

1.1 Methods



Phosphate HR, ortho with Tablet

1 – 80 mg/l PO₄ (Note 2)



Ø 24 mm

prepare Zero
press ZERO

1. Fill a clean vial (24 mm Ø) with **10 ml of the water sample**, close tightly with the cap.
2. Place the vial in the sample chamber making sure that the Σ marks are aligned.
3. Press **ZERO** key.
4. Remove the vial from the sample chamber.
5. Add **one PHOSPHATE HR P1 tablet** straight from the foil to the water sample and crush the tablet using a clean stirring rod.
6. Add **one PHOSPHATE HR P2 tablet** straight from the foil to the same water sample and crush the tablet using a clean stirring rod.
7. Close the vial tightly with the cap and swirl several times until the tablets are dissolved.
8. Place the vial in the sample chamber making sure that the Σ marks are aligned.
9. Press **TEST** key.

Wait for a **reaction period of 10 minutes**.

After the reaction period is finished the measurement starts automatically.

The result is shown in the display in mg/l ortho-Phosphate.

Zero accepted
prepare Test
press TEST

Countdown
10:00

1.1 Methods

Notes:

1. For samples under 5 mg/l PO_4 it is recommended to analyse the water sample with method 320 "Posphate LR, ortho with Tablet".
2. Only ortho-Phosphate ions react.
3. See also page 229.
4. Conversions:
 $\text{mg/l P} = \text{mg/l PO}_4 \times 0.33$
 $\text{mg/l P}_2\text{O}_5 = \text{mg/l PO}_4 \times 0.75$
5. ▲ PO_4
P
▼ P_2O_5

Reagent / Accessories	Form of reagent/Quantity	Order-No.
Set PHOSPHATE HR P 1 / P 2	Tablet / per 100 inclusive stirring rod	517661BT
PHOSPHATE HR P1	Tablet / 100	515810BT
PHOSPHATE HR P2	Tablet / 100	515820BT

1.1 Methods



Phosphate, ortho with Vario Powder Pack

0.06 – 2.5 mg/l PO₄



Ø 24 mm

prepare Zero
press ZERO

1. Fill a clean vial (24 mm Ø) with **10 ml of the water sample**, close tightly with the cap.
2. Place the vial in the sample chamber making sure that the Σ marks are aligned.
3. Press **ZERO** key.
4. Remove the vial from the sample chamber.

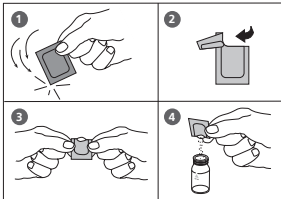

5. Add the contents of **one Vario Phosphate Rgt. F10 Powder Pack** straight from the foil to the water sample.
6. Close the vial tightly with the cap and swirl several times to mix the contents (approx. 10–15 sec., Note 1).
7. Place the vial in the sample chamber making sure that the Σ marks are aligned.

Zero accepted
prepare Test
press TEST

Countdown
2:00

8. Press **TEST** key.
Wait for a **reaction period of 2 minutes**.

After the reaction period is finished the measurement starts automatically.

The result is shown in the display in mg/l ortho-Phosphate.

1.1 Methods

Notes:

1. The reagent does not dissolve completely.
2. See also page 229.
3. Conversions:
 $\text{mg/l P} = \text{mg/l PO}_4 \times 0.33$
 $\text{mg/l P}_2\text{O}_5 = \text{mg/l PO}_4 \times 0.75$
4. ▲ PO₄
P
▼ P₂O₅

Reagent / Accessories	Form of reagent/Quantity	Order-No.
Set VARIO PHOS3 F10	Powder Pack / 2 x 50 VARIO PHOSPHATE RGT. F10	531550

1.1 Methods

3

2

4

Phosphate, ortho with Vario Tube Test

0.06 – 5 mg/l PO₄



1. Open one white capped **tube PO₄-P Dilution** and add **5 ml of water sample**.
2. Close the vials tightly with the caps and swirl several times to dissolve.
3. Place the vial in the sample chamber making sure that the marks  are aligned.

prepare Zero
press ZERO

4. Press **ZERO** key.
5. Remove the vial from the sample chamber.

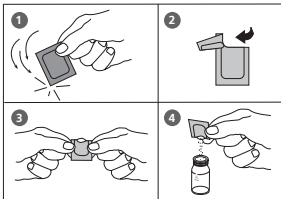

6. Add the contents of **one Vario Phosphate Rgt. F10 Powder Pack** straight from the foil to the water sample (Note 1).
7. Close the vial tightly with the cap and swirl several times to mix the contents (approx. 10–15 sec., Note 2).
8. Place the vial in the sample chamber making sure that the marks  are aligned.

Zero accepted
prepare Test
press TEST

9. Press **TEST** key.
Wait for a **reaction period of 2 minutes**.

Countdown
2:00

After the reaction period is finished the measurement starts automatically.

The result is shown in the display in mg/l ortho-Phosphate.

1.1 Methods

Notes:

1. Use a funnel to add the reagent.
2. The reagent does not dissolve completely.
3. See also page 229.
4. Conversions:
 $\text{mg/l P} = \text{mg/l PO}_4 \times 0.33$
 $\text{mg/l P}_2\text{O}_5 = \text{mg/l PO}_4 \times 0.75$
5. ▲ PO_4
P
▼ P_2O_5

Reagent / Accessories	Form of reagent/Quantity	Order-No.
Tube test contains: VARIO Dilution Vial VARIO PHOSPHATE RGT F10 PP VARIO deionised water	Set Reaction tube / 50 Powder Pack / 50 100 ml	535200

1.1 Methods



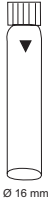

Phosphate, ortho (reactive) with Tube Test

3 – 60 mg/l PO₄



Ø 16 mm

prepare Zero
press ZERO

1. Place the supplied blank (red label) in the sample chamber making sure that the marks  are aligned.
2. Press **ZERO** key.
3. Remove the vial from the sample chamber.
4. Add **4 ml of water sample** into one reaction tube.
5. Close the vial tightly with the cap and invert several times to mix the contents.
6. Place the vial in the sample chamber making sure that the marks  are aligned.
7. Press **TEST** key.

Wait for a **reaction period of 3 minutes**.

After the reaction period is finished the measurement starts automatically.

The result is shown in the display in mg/l ortho-Phosphate.

Zero accepted
prepare Test
press TEST

Countdown
3:00

1.1 Methods

Notes:

1. Only ortho-Phosphate ions react.
2. See also page 229.

3. ▲ P
 PO_4
 ▼ P_2O_5

Reagent / Accessories	Form of reagent/Quantity	Order-No.
Reaction tube	Tube test / 24	2420701

1.1 Methods



Phosphate, acid hydrolyzable with Vario Tube Test

0.02 – 1.6 mg/l P



1. Open **one white capped digestion tube PO4-P Acid reagent** and add **5 ml of water sample**.
2. Close the vial tightly with the cap and invert gently several times to mix the contents.
3. Heat the vials for **30 minutes** in the preheated reactor at a temperature of **100°C**.
4. After 30 minutes remove the vial from the reactor. **(CAUTION: The vials are hot!)** Allow the vials to cool to room temperature.
5. Open the cooled digestion vial and add **2 ml 1.00 N Sodium hydroxide solution** to the vial.
6. Close the vial with the cap and invert the vial gently several times to mix the contents.
7. Place the vial in the sample chamber making sure that the marks  are aligned.

prepare Zero
press ZERO

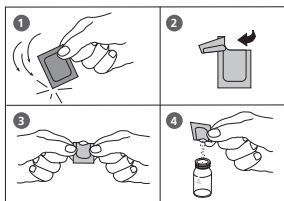

Zero accepted
prepare Test
press TEST

Countdown
2:00

8. Press **ZERO** key.
9. Remove the vial from the sample chamber.
10. Add the contents of **one Vario Phosphate Rgt. F10 Powder Pack** straight from the foil to the vial (Note 2).
11. Close the vial tightly with the cap and swirl several times to mix the contents (approx. 10-15 sec., Note 3).
12. Place the vial in the sample chamber making sure that the marks  are aligned.
13. Press **TEST** key.

Wait for a **reaction period of 2 minutes**.

After the reaction period is finished the measurement starts automatically.

The result is shown in the display in mg/l acid hydrolyzable Phosphate.

1.1 Methods

Notes:

1. Appropriate safety precautions and a good lab technique should be used during the whole procedure.
2. Use a funnel to add the reagent.
3. The reagent does not dissolve completely.
4. See also page 229.
5. Conversions:
 $\text{mg/l PO}_4 = \text{mg/l P} \times 3.07$
 $\text{mg/l P}_2\text{O}_5 = \text{mg/l P} \times 2.29$
6. ▲ PO_4
 P
 ▼ P_2O_5

Reagent / Accessories	Form of reagent/Quantity	Order-No.
Tube test contains: VARIO Acid Reagent Vial VARIO PHOSPHATE RGT F10 PP VARIO Potassium F10 Persulfate VARIO Sodium Hydroxide 1,54 N VARIO deionised water VARIO Sodium Hydroxide 1,00 N	Set Reaction tube / 50 Powder Pack / 50 Powder Pack / 50 Solution / 100 ml 100 ml Solution / 100 ml	535250

1.1 Methods

3 1 6

Phosphonates Persulfate UV oxidation method with Vario Powder Pack

0 – 125 mg/l (see Table 1)

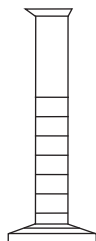

Ø 24 mm

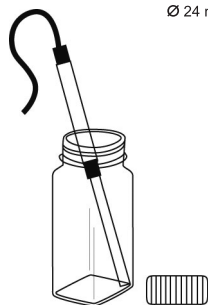

Countdown 1
10:00
start: ↙



Ø 24 mm

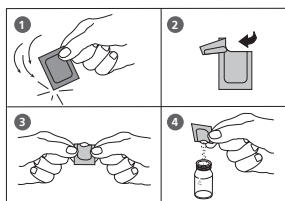

1. Choose the appropriate sample volume from table 1 (see following pages).
2. Pipette the chosen sample volume into a clean 50 ml graduated cylinder. If necessary fill up with deionised water to the 50 ml mark and mix well.
3. Fill a clean vial (24 mm Ø) with **10 ml of the prepared water sample** (this is the blank).
4. Transfer **25 ml of the prepared water sample** into the digestion vial.
5. Add the contents of **one Vario Potassium Persulfate F10 Powder Pack** straight from the foil to the digestion vial.
6. Close the digestion vial tightly with the cap and swirl until the reagent is dissolved completely.
7. Insert the UV lamp into the digestion vial (Note 3, 4, 5). **CAUTION: Wear UV safety goggles!**
8. Switch the UV lamp on and wait for a **reaction period of 10 minutes**.
9. After the reaction period is finished switch the UV lamp off and remove the lamp from the vial.
10. Fill a second vial (24 mm Ø) with **10 ml of the digested sample** (this is the sample).
11. Add the contents of **one Vario Phosphate Rgt. F10 Powder Pack** straight from the foil into each vial (blank and sample).
12. Close the vials tightly with the cap and swirl gently several times (30 sec.). (Note 6)

1.1 Methods

prepare Zero
press ZERO

Countdown
2:00

Zero accepted
prepare Test
press TEST

13. Place the vial (the blank) in the sample chamber making sure that the Σ marks are aligned.

14. Press **ZERO** key.

Wait for a **reaction period of 2 minutes** (Note 7).

After the reaction period is finished the measurement starts automatically.

15. Remove the vial from the sample chamber.

16. Place the vial (the sample) in the sample chamber making sure that the Σ marks are aligned.

17. Press **TEST** key.

The result is shown in the display in mg/L PO_4^{3-} .

To calculate the actual phosphonate concentration multiply the reading with the corresponding dilution factor from table 1.

To calculate the active phosphonate concentration multiply the actual phosphonate concentration using the appropriate factor from table 2.

Notes:

1. Rinse all glassware with 1:1 Hydrochloric acid first and then rinse with deionised water.
Do not use detergents with phosphates.
2. During UV digestion Phosphonates are converted to ortho-Phosphates.
This step is normally completed in 10 minutes. High organic loaded samples or a weak lamp can cause incomplete phosphate conversion.
3. UV lamp available on request.
4. While the UV lamp is on UV safety goggles must be worn.
5. For handling of the UV lamp see manufacturer's manual.
Do not touch the surface of the UV lamp. Fingerprints will etch the glass.
Wipe the UV lamp with a soft and clean tissue between measurements.
6. The reagent does not dissolve completely.
7. The given reaction time of 2 minutes refers to a water sample temperature of more than 15°C. At a sample temperature lower than 15 °C a reaction time of 4 minutes is required.

Tables:

see next page

1.1 Methods

Table 1:

Expected range (mg/L Phosphonate)	Sample volume in ml	Factor
0 – 2.5	50	0.1
0 – 5.0	25	0.2
0 – 12.5	10	0.5
0 – 25	5	1.0
0 – 125	1	5.0

Table 2:

Phosphonate type	Conversion factor for active phosphonate
PBTC	2.840
NTP	1.050
HEDPA	1.085
EDTMPA	1.148
HMDTMPA	1.295
DETPMPA	1.207
HPA	1.490

Reagent / Accessories	Form of reagent/Quantity	Order-No.
Set VARIO Potassium F10 Persulfate VARIO PHOSPHATE RGT F10 PP	Powder Pack / 100 Powder Pack / 200	535220

1.1 Methods

Interference levels decrease with increasing sample volume.

Example: Iron interferes above 200 mg/L if a sample volume of 5 ml is used.

At a sample volume of 10 ml the interference level decreases to 100 mg/L.

Table 3:

Interfering substances	Interference level using 5 ml of sample
Aluminium	100 mg/l
Arsenate	interferes at all concentrations
Benzotriazole	10 mg/l
Bicarbonate	1000 mg/l
Bromide	100 mg/l
Calcium	5000 mg/l
CDTA	100 mg/l
Chloride	5000 mg/l
Chromate	100 mg/l
Copper	100 mg/l
Cyanide	100 mg/l; increase the UV digestion to 30 minutes
Diethanoldithiocarbamate	50 mg/l
EDTA	100 mg/l
Iron	200 mg/l
Nitrate	200 mg/l
NTA	250 mg/l
ortho-Phosphate	15 mg/l
Phosphite and organophosphorus compounds	reacts quantitatively; Meta- and Polyphosphates do not interfere
Silica	500 mg/l
Silicate	100 mg/l
Sulfate	2000 mg/l
Sulfide	interferes at all concentrations
Sulfite	100 mg/l
Thiourea	10 mg/l
highly buffered samples or extreme sample pH	may exceed the buffering capacity of the reagents and require sample pretreatment

1.1 Methods

3 4 0

Potassium with Tablet

1 – 16 mg/l K



Ø 24 mm

prepare Zero
press ZERO

1. Fill a clean vial (24 mm Ø) with **10 ml of the water sample**, close tightly with the cap.
2. Place the vial in the sample chamber making sure that the Σ marks are aligned.
3. Press **ZERO** key.
4. Remove the vial from the sample chamber.
5. Add **one Potassium T tablet** straight from the foil to the water sample and crush the tablet using a clean stirring rod.
6. Close the vial tightly with the cap and swirl several times until the tablet is dissolved.
7. Place the vial in the sample chamber making sure that the Σ marks are aligned.
8. Press **TEST** key.

Zero accepted
prepare Test
press TEST

The result is shown in the display in mg/l Potassium.

1.1 Methods

Notes:

1. If Potassium is present a cloudy solution will appear.
Single particles are not necessarily caused by Potassium.

Reagent / Accessories	Form of reagent/Quantity	Order-No.
Potassium T	Tablet / 100	515670

1.1 Methods

Spectral Absorption Coefficient (S Abs)

0 – 50 m⁻¹



Spectral Absorption Coefficient at 436 nm (S Abs1)



Spectral Absorption Coefficient at 525 nm (S Abs2)



Spectral Absorption Coefficient at 620 nm (S Abs3)

Methods 345, 346 and 347 are called up one after the other and the water sample is analysed using the tests as described below:

Sample preparation:

1. Filter the water sample through a membrane filter with a pore width of 0.45 µm. (At least 100 ml of the water sample should be filtered.)

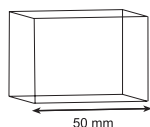

prepare Zero
press ZERO

Performing test procedure:

2. Fill a clean 50 mm cell with **deionised water** (Note 1).
3. Place the cell in the sample chamber making sure that the positioning is correct.
4. Press **ZERO** key.
5. Remove the cell from the sample chamber and empty the cell.
6. Use some of the filtered water sample to rinse out the cell, then fill the sample into the cell.
7. Immediately place the cell in the sample chamber making sure that the positioning is correct.
8. Press **TEST** key.

Zero accepted
prepare Test
press TEST

The result is shown in the display in (m⁻¹).

1.1 Methods

Notes:

1. Filter the deionised water for zero calibration through a membrane filter with a pore width of 0.45 μm .
2. The test complies with standard EN ISO 7887 : 1994, main section 3.
3. As colorations depend on pH and temperature, these parameters should be determined together with optical measurement and specified along with the result.
4. The spectral absorption coefficient is a variable used to describe the true coloration of a water sample. The "true coloration" of a water sample is the coloration caused solely by dissolved substances in the sample. This is why the water sample has to be filtered prior to measurement.

Measurement at a wavelength of 436 nm is obligatory and is adequate for natural waters and the outflow of municipal sewage plants. As industrial waste waters often have no pronounced extinction maxima, additional measurements are required at the wavelengths 525 nm and 620 nm. In case of doubt, you should perform a wavelength scan from 330 to 780 nm using the spectrum function (mode 53).

1.1 Methods



Silica/Silicon dioxide with Tablet

0.05 – 3 mg/l SiO₂



Ø 24 mm

prepare Zero
press ZERO

Countdown
5:00
start: ↓

Zero accepted
prepare Test
press TEST

Countdown
2:00

1. Fill a clean vial (24 mm ø) with **10 ml of the water sample**, close tightly with the cap.
2. Place the vial in the sample chamber making sure that the Σ marks are aligned.
3. Press **ZERO** key.
4. Remove the vial from the sample chamber.
5. Add **one SILICA No. 1 tablet** straight from the foil to the water sample and crush the tablet using a clean stirring rod.
6. Close the vial tightly with the cap and swirl several times until the tablet is dissolved.
7. Press **[↓]** key.
Wait for a **reaction period of 5 minutes**.
After the reaction period is finished proceed as follows:
8. Add **one SILICA PR tablet** straight from the foil to the same water sample and crush the tablet using a clean stirring rod.
9. Add **one SILICA No. 2 tablet** straight from the foil to the same water sample and crush the tablet using a clean stirring rod.
10. Close the cap tightly and swirl the vial several times until the tablets are dissolved.
11. Place the vial in the sample chamber making sure that the Σ marks are aligned.
12. Press **TEST** key.
Wait for a **reaction period of 2 minutes**.
After the reaction period is finished the measurement starts automatically.

The result is shown in the display in mg/l Silica.

1.1 Methods

Notes:

1. The tablets must be added in the correct sequence.
2. Phosphate ions do not interfere under the given reaction conditions.

3. Conversion:

$$\text{mg/l Si} = \text{mg/l SiO}_2 \times 0.47$$

4. ▲ SiO₂
▼ Si

Reagent / Accessories	Form of reagent/Quantity	Order-No.
Set SILICA No. 1 / No. 2	Tablet / per 100 inclusive stirring rod	517671BT
SILICA No. 1	Tablet / 100	513130BT
SILICA No. 2	Tablet / 100	513140BT
SILICA PR	Tablet / 100	513150BT

1.1 Methods

3 5 1

Silica LR / Silicon dioxide LR with Vario Powder Pack and Liquid Reagent

0.1 – 1.6 mg/l SiO₂

Use two clean vials (24 mm Ø) and mark one as blank for zeroing.



Countdown
4:00
start: ↓

1. Fill each vial with **10 ml of water sample**.
2. Add **0.5 ml Vario Molybdate 3 reagent solution** into each vial.
3. Close the vials tightly with the caps and swirl several times to mix the contents (Note 1).
4. Press **[↵]** key.

Wait for a **reaction period of 4 minutes** (Note 2).

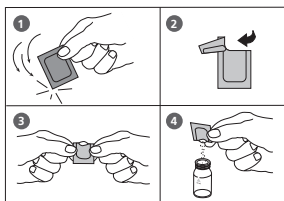

After the reaction period is finished proceed as follows:

5. Add the contents of **one Vario Silica Citric Acid F10 Powder Pack** straight from the foil into each vial.
6. Close the vials tightly with the caps and swirl several times to mix the contents.
7. Press **[↵]** key.

Wait for a **reaction period of 1 minute** (Note 3).

After the reaction period is finished proceed as follows:

8. Place the vial (the blank) in the sample chamber making sure that the Σ marks are aligned.
9. Add the contents of **one Vario LR Silica Amino Acid F F10 Powder Pack** straight from the foil into the vial (the sample).
10. Close the vial tightly with the cap and swirl several times to mix the contents.

1.1 Methods

prepare Zero
press ZERO

Countdown
2:00

- Press **ZERO** key (blank is already placed in the sample chamber – see point 8).

Wait for a **reaction period of 2 minutes**.

After the reaction period is finished the zero-reading starts automatically.

- Remove the vial from the sample chamber.
- Place the vial (the sample) in the sample chamber making sure that the Σ marks are aligned.

Zero accepted
prepare Test
press TEST

- Press **TEST** key.

The result is shown in the display in mg/l Silica.

Notes:

- Close the vials with the cap immediately after adding the Vario Molybdate 3 reagent solution, otherwise low readings may result.
- The given reaction time of 4 minutes refers to a water sample temperature of 20°C. At 30°C a reaction time of 2 minutes, at 10°C a reaction time of 8 minutes are required.
- The given reaction time of 1 minute refers to a water sample temperature of 20°C. At 30°C a reaction time of 30 seconds, at 10°C a reaction time of 2 minutes are required.
- Interferences:

Substance	Interference
Iron	large amounts interfere
Phosphate	does not interfere at concentrations less than 50 mg/l PO ₄ at 60 mg/l PO ₄ the interference is approx. – 2% at 75 mg/l PO ₄ the interference is approx. – 11%
Sulfide	interferes at all levels

Occasionally water samples contain forms of silica which reacts very slowly with Molybdate. The nature of these forms is not known.

A pre-treatment with Sodium hydrogencarbonate and then with Sulfuric Acid will make these forms reactive to Molybdate (pre-treatment is given in "Standard methods for the Examination of Water and Wastewater" under "Silica Digestion with Sodium Bicarbonate").

- ▲ SiO₂
▼ Si

Reagent / Accessories	Form of reagent/Quantity	Order-No.
Set VARIO LR Silica Amino Acid F10 VARIO Silica Citric Acid F10 VARIO Molybdate 3	Powder Pack / 100 Powder Pack / 200 Liquid reagent / 2x 50 ml	535690

1.1 Methods

3 5 2

Silica HR / Silicon dioxide HR with Vario Powder Pack

1 – 100 mg/l SiO₂



prepare Zero
press ZERO

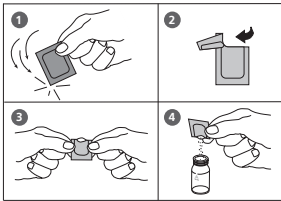

Countdown
10:00
start: ↓

Zero accepted
prepare Test
press TEST

Countdown
2:00

1. Fill a clean vial (24 mm Ø) with **10 ml of the water sample** (Note 1), close tightly with the cap.
2. Place the vial in the sample chamber making sure that the Σ marks are aligned.
3. Press **ZERO** key.
4. Remove the vial from the sample chamber.
5. Add the contents of **one Vario Silica HR Molybdate F10 Powder Pack** straight from the foil to the water sample.
6. Close the vial tightly with the cap and swirl several times to mix the contents.
7. Add the contents of **one Vario Silica HR Acid Rgt. F10 Powder Pack** straight from the foil to the same water sample (Note 2).
8. Close the vial tightly with the caps and swirl several times to mix the contents.
9. Press **[Σ]** key.

Wait for a **reaction period of 10 minutes**.

After the reaction period is finished proceed as follows:

10. Add the contents of **one Vario Silica Citric Acid F10 Powder Pack** straight from the foil to the water sample (Note 3).
11. Close the vial tightly with the cap and swirl several times to mix the contents.
12. Place the vial in the sample chamber making sure that the Σ marks are aligned.
13. Press **TEST** key.

Wait for a **reaction period of 2 minutes**.

After the reaction period is finished the measurement starts automatically.

The result is shown in the display in mg/l Silica.

1.1 Methods

Notes:

1. Temperature of the sample should be 15°C – 25°C.
2. If Silica or Phosphate is present a yellow colour is developed.
3. In this step any yellow colour due to Phosphate is removed.
4. Interferences:

Substance	Interference
Iron	large amounts interfere
Phosphate	does not interfere at concentrations less than 50 mg/l PO ₄ at 60 mg/l PO ₄ the interference is approx. – 2% at 75 mg/l PO ₄ the interference is approx. – 11%
Sulfide	interferes at all levels

Occasionally water samples contain forms of silica which reacts very slowly with Molybdate. The nature of these forms is not known.

A pre-treatment with Sodium hydrogencarbonate and then with Sulfuric Acid will make these forms reactive to Molybdate (pre-treatment is given in "Standard methods for the Examination of Water and Wastewater" under "Silica Digestion with Sodium Bicarbonate").

5. \blacktriangle SiO₂
 \blacktriangledown Si

Reagent / Accessories	Form of reagent/Quantity	Order-No.
Set VARIO Silica HR Molybdate F10 VARIO Silica HR Acid Rgt F10 VARIO Silica HR Citric Acid F10	Powder Pack / 100 Powder Pack / 100 Powder Pack / 100	535700

1.1 Methods

3 6 0

Sulfate with Vario Powder Pack

2 – 100 mg/l SO₄



1. Fill a clean vial (24 mm Ø) with **10 ml of the water sample**, close tightly with the cap.
2. Place the vial in the sample chamber making sure that the Σ marks are aligned.

prepare Zero
press ZERO

3. Press **ZERO** key.
4. Remove the vial from the sample chamber.

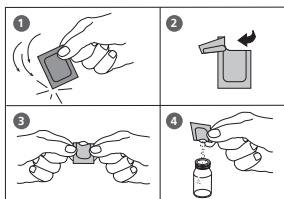

5. Add the contents of **one Vario Sulpha 4/F10 Powder Pack** straight from the foil to the water sample.
6. Close the vial tightly with the cap and swirl several times to mix the contents.
7. Place the vial in the sample chamber making sure that the Σ marks are aligned.

Zero accepted
prepare Test
press TEST

8. Press **TEST** key.

Wait for a **reaction period of 5 minutes**.

Countdown
5:00

After the reaction period is finished the measurement starts automatically.

The result is shown in the display in mg/l Sulfate.

1.1 Methods

Note:

1. If Sulfate ions are present a cloudy solution will appear.

Reagent / Accessories	Form of reagent/Quantity	Order-No.
VARIO Sulpha 4 / F10	Powder Pack / 100	532160

1.1 Methods

3

6

5

Sulfide with Tablet

0.04 – 0.5 mg/l S⁻



Ø 24 mm

prepare Zero
press ZERO

1. Fill a clean vial (24 mm Ø) with **10 ml of the water sample**, close tightly with the cap.
2. Place the vial in the sample chamber making sure that the Σ marks are aligned.

3. Press **ZERO** key.

4. Remove the vial from the sample chamber.

5. Add **one SULFIDE No. 1 tablet** to the water sample and crush the tablet using a clean stirring rod and dissolve the tablet.

6. Add **one SULFIDE No. 2 tablet** to the same water sample and crush the tablet using a clean stirring rod.

7. Close the vial tightly with the cap and swirl several times until the tablets are dissolved.

8. Place the vial in the sample chamber making sure that the Σ marks are aligned.

9. Press **TEST** key.

Wait for a **reaction period of 10 minutes**.

Zero accepted
prepare Test
press TEST

Countdown
10:00

After the reaction period is finished the measurement starts automatically.

The result is shown in the display in mg/l Sulfide.

1.1 Methods

Notes:

1. The tablets must be added in the correct sequence.
2. Chlorine and other oxidizing agents which react with DPD do not interfere with the test.
3. To avoid loss of Sulfide collect the sample carefully with a minimum of aeration. It is essential to test the sample immediately after collection.
4. The sample temperature should be 20°C. A different temperature can lead to higher or lower results.
5. Conversion:
$$H_2S = \text{mg/l S} \times 1.06$$
6. ▲ S
▼ H₂S

Reagent / Accessories	Form of reagent/Quantity	Order-No.
SULFIDE No. 1	Tablet / 100	502930
SULFIDE No. 2	Tablet / 100	502940

1.1 Methods

3

6

8

Sulfite with Tablet

0.1 – 10 mg/l SO₃



10 mm

prepare Zero
press ZERO

1. Fill a clean 10 mm cell with **water sample**.
2. Place the cell in the sample chamber making sure that the positioning is correct.
3. Press **ZERO** key.
4. Remove the cell from the sample chamber. Empty the cell and dry completely.
5. Fill a beaker with **10 ml water sample**.
6. Add **one SULFITE LR tablet** straight from the foil and crush the tablet using a clean stirring rod. Dissolve the tablet.
7. Fill the 10 mm cell with the coloured test solution.
8. Place the cell in the sample chamber making sure that the positioning is correct.

Zero accepted
prepare Test
press TEST

Countdown
5:00

9. Press **TEST** key.

Wait for a **reaction period of 5 minutes**.

After the reaction period is finished the measurement starts automatically.

The result is shown in the display in mg/l Sulfite.

1.1 Methods

Notes:

1. ▲ SO_3
▼ Na_2SO_3

Reagent / Accessories	Form of reagent/Quantity	Order-No.
SULFITE LR	Tablet / 100	518020BT

1.1 Methods

3 7 0

Sulfite with Tablet

0.05 – 4 mg/l SO₃



Ø 24 mm

prepare Zero
press ZERO

1. Fill a clean vial (24 mm Ø) with **10 ml of the water sample**, close tightly with the cap.
2. Place the vial in the sample chamber making sure that the Σ marks are aligned.

3. Press **ZERO** key.

4. Remove the vial from the sample chamber.

5. Add **one SULFITE LR tablet** straight from the foil to the water sample and crush the tablet using a clean stirring rod.

6. Close the vial tightly with the cap and swirl several times until the tablet is dissolved.

7. Place the vial in the sample chamber making sure that the Σ marks are aligned.

8. Press **TEST** key.

Wait for a **reaction period of 5 minutes**.

After the reaction period is finished the measurement starts automatically.

The result is shown in the display in mg/l Sulfite.

Zero accepted
prepare Test
press TEST

Countdown
5:00

1.1 Methods

Notes:

1. ▲ SO_3
▼ Na_2SO_3

Reagent / Accessories	Form of reagent/Quantity	Order-No.
SULFITE LR	Tablet / 100	518020BT

1.1 Methods

3

7

5

Surfactants, anionic with MERCK Spectroquant® Cell Test, No. 1.14697.0001

0,05 – 2 mg/l MBAS



Use two clean Reagent tubes and mark one as blank for zeroing.

Ø 16 mm

1. Add **5 ml deionised water** in the vial marked as blank **(this is the blank, note 6). Do not mix contents!**
2. Fill the second prepared vial with **5 ml of the water sample (this is the test solution, note 6). Do not mix contents!**
3. Fill each vial with drops of the same size by holding the bottle vertically and squeeze slowly:

2 drops reagent T-1K

4. Close the vials tightly with the caps and **shake for 30 seconds.**
5. Place the vial **(the blank)** in the sample chamber making sure that the  marks are aligned.

prepare Zero
press ZERO

6. Press **ZERO** key.
7. Remove the vial from the sample chamber.

Countdown
10:00
start: ↓

8. Press **[↓]** key.
Wait for a **reaction period of 10 minutes.**
After the reaction period is finished proceed as follows:

1.1 Methods

9. **Swirl the vial (the sample)** and then place the vial **(the sample)** in the sample chamber making sure that the marks  are aligned. **(note 8)**

**Zero accepted
prepare Test
press TEST**

10. Press **TEST** key.

The result is shown in the display in mg/l MBAS.

Notes:

1. This method is adapted from MERCK.
2. Before performing the test read the original test instructions (delivered with the test) and the MSDS (available at www.merckmillipore.com).
3. Spectroquant® is a registered trade mark of the company MERCK KGaA.
4. Appropriate safety precautions and good lab technique should be used during the whole procedure.
5. Because reaction depends on temperature, **sample and tube temperature must be between 10 and 20°C.**
6. Sample volume should always be metered by using volumetric pipette (class A).
7. Store the reagents in closed containers at a temperature of + 15°C to + 25°C.
8. Swirl the cell before the measurement. Should the lower phase be turbid, warm the cell briefly with the hand.
9. The test sample should have a pH of between 5 and 10.
10. MBAS = **M**ethylene **B**lue **A**ctive **S**ubstances, calculated as sodium 1-dodecanesulfonate

Reagent / Accessories	Form of reagent/Quantity	Order-No.
MERCK Spectroquant® 1.14697.0001	Cell Test / 25 Tests	420763

1.1 Methods

3 7 6

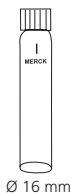

Surfactants, anionic with MERCK Spectroquant® Cell Test, No. 1.02552.0001

0.05 – 2 mg/l SDSA¹⁾
0.06 – 2.56 mg/l SDBS²⁾
0.05 – 2.12 mg/l SDS³⁾
0.08 – 3.26 mg/l SDOSSA⁴⁾

Use two clean Reagent tubes and mark one as blank for zeroing.

1. Add **5 ml deionised water** in the vial marked as blank (**this is the blank, note 6**). **Do not mix contents!**
2. Fill the second prepared vial with **5 ml of the water sample (this is the sample, note 6)**. **Do not mix contents!**
3. Fill each vial with drops of the same size by holding the bottle vertically and squeeze slowly:
2 drops reagent T-1K
4. Close the vials tightly with the caps and **shake vigorously for 30 seconds**.

Countdown
10:00
start: ↴

5. Press **[↴]** key.
Wait for a **reaction period of 10 minutes**.
After the reaction period is finished proceed as follows:
6. **Swirl the vial (the blank)** and then place the vial (**the blank**) in the sample chamber making sure that the marks  are aligned. (**note 7**)

prepare Zero
press ZERO

7. Press **ZERO** key.
8. Remove the vial from the sample chamber.

1.1 Methods

9. **Swirl the vial (the sample)** and then place the vial **(the sample)** in the sample chamber making sure that the marks  are aligned. **(note 7)**

**Zero accepted
prepare Test
press TEST**

10. Press **TEST** key.

The result is shown in the display in mg/l SDSA.

Notes:

1. This method is adapted from MERCK.
2. Before performing the test read the original test instructions (delivered with the test) and the MSDS (available at www.merckmillipore.com).
3. Spectroquant® is a registered trade mark of the company MERCK KGaA.
4. Appropriate safety precautions and good lab technique should be used during the whole procedure.
5. Because reaction depends on temperature, tube temperature must be between **15 and 20°C**; sample temperature must be between **10 and 20°C**.
6. Sample volume should always be metered by using volumetric pipette (class A).
7. Should the lower phase be turbid, warm the cell briefly with the hand.
8. The test sample should have a pH value between 5 and 10.
9. ▲ SDSA¹⁾
 SDBS²⁾
 SDS³⁾
 ▼ SDOSSA⁴⁾

Reagent / Accessories	Form of reagent/Quantity	Order-No.
MERCK Spectroquant® 1.02552.0001	Cell Test / 25 Tests	420763

¹⁾ calculated as sodium 1-dodecanesulfonate (APHA 5540, ASTM 2330-02, ISO 7875-1)

²⁾ calculated as sodium dodecylbenzenesulfonate (EPA 425.1)

³⁾ calculated as sodium dodecyl sulfate

⁴⁾ calculated as Sodium dioctyl sulfosuccinate

1.1 Methoden

3 7 7

Surfactants, nonionic with MERCK Spectroquant® Cell Test, No. 1.01787.0001

0.1 – 7.5 mg/l Triton® X-100

0.11 – 8.25 mg/l NP 10



Use two clean Reagent tubes and mark one as blank for zeroing.

1. Add **4 ml deionised water** in the vial marked as blank (**this is the blank, note 6**).
2. Fill the second prepared vial with **4 ml of the water sample (this is the sample, note 6)**.
3. Close the vials tightly with the caps and shake vigorously for **1 minute**.

Countdown
2:00
start: ↵

4. Press **[↵]** key.

Wait for a **reaction period of 2 minutes**.

After the reaction period is finished proceed as follows:

5. **Swirl the vial (the blank)** and then place the vial (**the blank**) in the sample chamber making sure that the marks  are aligned.

prepare Zero
press ZERO

6. Press **ZERO** key.

7. Remove the vial from the sample chamber.

8. **Swirl the vial (the sample)** and then place the vial (**the sample**) in the sample chamber making sure that the marks  are aligned.

Zero accepted
prepare Test
press TEST

9. Press **TEST** key.

The result is shown in the display in mg/l Triton® X-100.

1.1 Methoden

Notes:

1. This method is adapted from MERCK.
2. Before performing the test read the original test instructions (delivered with the test) and the MSDS (available at www.merckmillipore.com).
3. Spectroquant® is a registered trade mark of the company MERCK KGaA.
4. Appropriate safety precautions and good lab technique should be used during the whole procedure.
5. Because reaction depends on temperature, sample and tube temperature must be between **20 and 25°C**.
6. Sample volume should always be metered by using volumetric pipette (class A).
7. The test sample should have a pH value between 3 and 9.
8. Triton® is a registered trade mark of the company DOW Chemical Company.
9. ▲ Triton® X-100
▼ NP 10

Reagent / Accessories	Form of reagent/Quantity	Order-No.
MERCK Spectroquant® 1.01787.0001	Cell Test / 25 Tests	420764

¹⁾ Nonylphenol Ethoxylat

1.1 Methods



Surfactants, cationic with MERCK Spectroquant® Cell Test, No. 1.01764.0001

0.05 – 1.5 mg/l CTAB

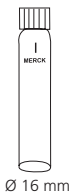

Use two clean Reagent tubes and mark one as blank for zeroing.

1. Add **5 ml deionised water** in the vial marked as blank **(this is the blank, note 6). Do not mix contents!**
2. Fill the second prepared vial with **5 ml of the water sample (this is the sample, note 6). Do not mix contents!**
3. Pipette **0.5 ml reagent T-1K** into each vial. **(note 6)**
4. Close the vials tightly with the caps and swirl for **30 seconds**.

Countdown
5:00
start: ↵

5. Press **↵** key.
Wait for a **reaction period of 5 minutes**.
After the reaction period is finished proceed as follows:
6. Place the vial **(the blank)** in the sample chamber making sure that the marks **Δ** are aligned. **(note 9)**

prepare Zero
press ZERO

7. Press **ZERO** key.
8. Remove the vial from the sample chamber.
9. Place the vial **(the sample)** in the sample chamber making sure that the marks **Δ** are aligned. **(note 9)**

Zero accepted
prepare Test
press TEST

10. Press **TEST** key.
The result is shown in the display in mg/l CTAB.

1.1 Methods

Notes:

1. This method is adapted from MERCK.
2. Before performing the test read the original test instructions (delivered with the test) and the MSDS (available at www.merckmillipore.com).
3. Spectroquant® is a registered trade mark of the company MERCK KGaA.
4. Appropriate safety precautions and good lab technique should be used during the whole procedure.
5. Because reaction depends on temperature, sample and tube temperature must be between **20 and 25°C**.
6. Sample volume should always be metered by using volumetric pipette (class A).
7. CTAB = calculated as N-cetyl-N,N,N-trimethylammonium bromide
8. The test sample should have a pH value between 3 and 8.
9. Should the lower phase be turbid, warm the cell briefly with the hand.

Reagent / Accessories	Form of reagent/Quantity	Order-No.
MERCK Spectroquant® 1.01764.0001	Cell Test / 25 Tests	420765

1.1 Methods



Suspended Solids

0 – 750 mg/l TSS

Sample preparation:

Blend approx. 500 ml of the water sample in a blender at high speed for 2 minutes.

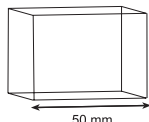

1. Fill a clean 50 mm cell with **deionised water**.
2. Place the vial in the sample chamber making sure that the Σ marks are aligned.
3. Press **ZERO** key.
4. Remove the vial from the sample chamber and empty the vial completely.
5. Stir the blended water sample. Use some of the water sample to rinse out the cell, then fill the sample into the cell.
6. Place the vial in the sample chamber making sure that the Σ marks are aligned.
7. Press **TEST** key.

prepare Zero
press ZERO

Zero accepted
prepare Test
press TEST

The result is shown in the display in mg/l TSS (Total Suspended Solids).

1.1 Methods

Note:

1. The photometric determination of Suspended Solids is based on a gravimetric method.
In a lab this is usually done by evaporation of the filter residue of a filtrated water sample in an oven at 103°C – 105°C and weighing of the dried residue.
2. When higher accuracy is required perform a gravimetric determination of a water sample. The result can be used to calibrate the photometer with the same water sample.
3. The estimated detection limit is 20 mg/L TSS.
4. Collect water samples in clean plastic or glass bottles and analyse the water sample as soon as possible. It is possible to store the sample at 4°C for 7 days. Before measurement warm up the sample to the temperature at collection time.
5. Interferences:
 - Air bubbles interfere and can be removed by swirling the vial gently.
 - Colour interferes if light is absorbed at 660 nm.

1.1 Methods



TOC LR with MERCK Spectroquant® Cell Test, No. 1.14878.0001

5.0 – 80.0 mg/l TOC

Use two clean suitable glass containers and mark one as blank for zeroing.

1. Fill a clean glass container with **25 ml of deionised water** (this is the **blank**).
2. Fill the other clean glass container with **25 ml of the water sample** (this is the **sample**).
3. Fill each glass container with drops of the same size by holding the bottle vertically and squeeze slowly:
3 drops reagent TOC-1K and mix.
4. pH value of the solution must be below 2.5.
If necessary adjust the pH with sulphuric acid.
5. Stir for **10 minutes** at medium speed (magnetic stirrer, stirring staff).



Digestion:

Use two clean reaction tubes (16 mm Ø) and mark one as **blank** for zeroing.

Ø 16 mm

6. Pipette **3 ml pre-prepared blank** into one reaction tube (blank).
7. Pipette **3 ml pre-prepared sample** into one reaction tube (sample).
8. Add **1 level microspoon of reagent TOC-2K** to each reaction tube.
9. **Immediately** close the vials tightly with an aluminium cap.

1.1 Methods

10. Heat vials, **standing on its head**, at **120°C** in the pre-heated reactor for **120 minutes**.

11. Wait for 1 hour before proceeding.

Do not cool down with water! After cooling, turn the cell upright and measure in the photometer **within 10 min.**

Performing test procedure:

Insert the adapter for 16 mm Ø vials.

10. Place the cooled down blank in the sample chamber making sure that the marks \times are aligned.

**prepare Zero
press ZERO**

11. Press **ZERO** key.

12. Remove the vial from the sample chamber.

13. Place the cooled down sample in the sample chamber making sure that the marks \times are aligned.

**Zero accepted
prepare Test
press TEST**

14. Press **TEST** key.

The result is shown in the display in mg/l TOC.

Notes:

1. This method is adapted from MERCK.
2. Before performing the test read the original test instructions (delivered with the test) and the MSDS (available at www.merckmillipore.com).
3. Spectroquant® is a registered trade mark of the company MERCK KGaA.
4. Appropriate safety precautions and good lab technique should be used during the whole procedure.
5. Sample volume should always be metered by using volumetric pipette (class A).
6. TOC = **T**otal **O**rganic **C**arbon

Reagent / Accessories	Form of reagent/Quantity	Order-No.
MERCK Spectroquant® 1.14878.0001	Cell Test / 25 tests	420756
Screw caps 1.73500.0001	6 units	420757

1.1 Methods

3

8

1

TOC HR with MERCK Spectroquant® Cell Test, No. 1.14879.0001

50 – 800 mg/l TOC

Use two clean suitable glass containers and mark one as blank for zeroing.

1. Fill a clean glass container with **10 ml of deionised water** (this is the **blank**).
2. Fill the other clean glass container with **1 ml of the water sample**. Add **9 ml deionised water** and mix (this is the **sample**).
3. Fill each glass container with drops of the same size by holding the bottle vertically and squeeze slowly:
2 drops reagent TOC-1K and mix.
4. pH value of the solution must be below 2.5.
If necessary adjust the pH with sulphuric acid.
5. Stir for **10 minutes** at medium speed (magnetic stirrer, stirring staff).



Digestion:

Use two clean reaction tubes (16 mm Ø) and mark one as **blank** for zeroing.

Ø 16 mm

6. Pipette **3 ml pre-prepared blank** into one reaction tube (blank).
7. Pipette **3 ml pre-prepared sample** into one reaction tube (sample).
8. Add **1 level microspoon of reagent TOC-2K to each** reaction tube.

1.1 Methods

9. **Immediately** close the vials tightly with an aluminium cap.
10. Heat vials, **standing on its head**, at **120°C** in the pre-heated reactor for **120 minutes**.
11. Wait for 1 hour before proceeding.
Do not cool down with water! After cooling, turn the cell upright and measure in the photometer **within 10 min**.

Performing test procedure:

Insert the adapter for 16 mm Ø vials.

10. Place the cooled down blank in the sample chamber making sure that the marks \times are aligned.
11. Press **ZERO** key.
12. Remove the vial from the sample chamber.
13. Place the cooled down sample in the sample chamber making sure that the marks \times are aligned.

**prepare Zero
press ZERO**

14. Press **TEST** key.

The result is shown in the display in mg/l TOC.

**Zero accepted
prepare Test
press TEST**

Notes:

1. This method is adapted from MERCK.
2. Before performing the test read the original test instructions (delivered with the test) and the MSDS (available at www.merckmillipore.com).
3. Spectroquant® is a registered trade mark of the company MERCK KGaA.
4. Appropriate safety precautions and good lab technique should be used during the whole procedure.
5. Sample volume should always be metered by using volumetric pipette (class A).
6. TOC = Total **O**rganic **C**arbon

Reagent / Accessories	Form of reagent/Quantity	Order-No.
MERCK Spectroquant® 1.14879.0001	Cell Test / 25 tests	420756
Screw caps 1.73500.0001	6 units	420757

1.1 Methods



Turbidity

5 – 500 FAU

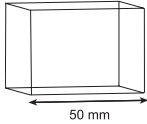

1. Fill a clean 50 mm cell with **deionised water**.
2. Place the cell in the sample chamber making sure that the positioning is correct.
3. Press **ZERO** key.
4. Remove the cell from the sample chamber and empty completely.
5. Stir the water sample. Use some of the water sample to rinse out the cell, then fill the sample into the cell.
6. Place the cell in the sample chamber making sure that the positioning is correct.
7. Press **TEST** key.

prepare Zero
press ZERO

Zero accepted
prepare Test
press TEST

The result is shown in the display in FAU.

1.1 Methods

Notes:

1. This test uses an attenuated radiation method for the reading of FAU (Formazin Attenuation Units). The results can not be used for USEPA reporting purposes, but it may be used for routine measurements. The attenuated radiation method is different from the Nephelometric method.
2. Collect water samples in clean plastic or glass bottles and analyse the water sample as soon as possible. It is possible to store the sample at 4°C for 48 hours. Before measurement warm up the sample to the temperature at collection time. Temperature differences between measurement and sample collection can effect the turbidity of the sample.
3. Colour interference is minimized through measurement at 860 nm. Interferences depend on light absorption at 860 nm and gas bubbles.
4. Air bubbles interfere and can be removed using an ultrasonic bath.

1.1 Methods

3 9 0

Urea with Tablet and Liquid Reagent

0.1 – 2 mg/l $(\text{NH}_2)_2\text{CO}$ / mg/l Urea



Ø 24 mm

prepare Zero
press ZERO

1. Fill a clean vial (24 mm Ø) with **10 ml of the water sample**, close tightly with the cap.
2. Place the vial in the sample chamber making sure that the Σ marks are aligned.
3. Press **ZERO** key.
4. Remove the vial from the sample chamber.
5. In the presence of free Chlorine (HOCl), add **one UREA PRETREAT tablet** straight from the foil and crush the tablet using a clean stirring rod (Note 10).
6. Close the vial tightly with the cap and swirl several times to mix the contents.
7. Add **2 drops of Urea reagent 1** to the water sample (Note 9).
8. Close the vial tightly with the cap and swirl several times to mix the contents.
9. Add **1 drop of Urea Reagent 2** (Urease) to the same water sample (Note 9).
10. Close the vial tightly with the cap and swirl several times to mix the contents.

Countdown
5:00
start: ↓

11. Press **[↓]** key.

Wait for a **reaction period of 5 minutes**.

After the reaction period is finished proceed as follows:

12. Add **one AMMONIA No. 1 tablet** straight from the foil to the prepared water sample and mix to dissolve with a clean stirring rod.
13. Add **one AMMONIA No. 2 tablet** straight from the foil to the same water sample and mix to dissolve with a clean stirring rod.

1.1 Methods

14. Close the vial tightly with the cap and swirl several times until the tablets are dissolved.
15. Place the vial in the sample chamber making sure that the Σ marks are aligned.
16. Press **TEST** key.
Wait for a **reaction period of 10 minutes**.

Zero accepted
prepare Test
press TEST

Countdown
10:00

After the reaction period is finished the measurement starts automatically.

The result is shown in the display in mg/l Urea.

Notes:

1. The sample temperature should be between 20°C and 30°C.
2. Carry out the test at the latest one hour after sample taking.
3. Concentrations above 2 mg/l Urea can produce results inside the measuring range.
In this case, the water sample should be diluted with Urea free water and remeasured.
4. The tablets must be added in the correct sequence.
5. The AMMONIA No. 1 tablet will only dissolve completely after the AMMONIA No. 2 tablet has been added.
6. **Do not store reagent 1 (Urease) below 10°C; granulation is possible.**
Store reagent 2 (Urease) in the refrigerator at a temperature of 4°C to 8°C.
7. Ammonia and chloramines are also measured during urea measurement.
8. Before analysing seawater samples, a measuring spoon of Ammonia Conditioning Powder must be added to the sample and swirled to dissolve before AMMONIA No. 1 tablet is added.
9. Fill the vial with drops of the same size by holding the bottle vertically and squeeze slowly.
10. One UREA PRETREAT tablet compensates for the interference of free Chlorine up to 2 mg/l (two tablets up to 4 mg/l, three tablets up to 6 mg/l).

Reagent / Accessories	Form of reagent/Quantity	Order-No.
UREA PRETREAT	Tablet / 100	516110BT
UREA Reagent 1	Liquid reagent / 15 ml	459300
UREA Reagent 2	Liquid reagent / 10 ml	459400
Set AMMONIA No. 1 / No. 2	Tablet / per 100 inclusive stirring rod	517611BT
AMMONIA No. 1	Tablet / 100	512580BT
AMMONIA No. 2	Tablet / 100	512590BT

1.1 Methods

4 0 0

Zinc with Tablet

0.02 – 0.9 mg/l Zn



Ø 24 mm

1. Fill a clean vial (24 mm Ø) with **10 ml of the water sample**.
2. Add **one COPPER / ZINC LR tablet** straight from the foil to the water sample, crush the tablet using a clean stirring rod.
3. Close the vial tightly with the cap and swirl several times until the tablet is dissolved.
4. Place the vial in the sample chamber making sure that the Σ marks are aligned.

prepare Zero
press ZERO

Countdown
5:00

5. Press **ZERO** key.
Wait for a **reaction period of 5 minutes**.

After the reaction period is finished the measurement starts automatically.

6. Remove the vial from the sample chamber.
7. Add **one EDTA tablet** straight from the foil to the prepared vial and crush the tablet using a clean stirring rod.
8. Close the vial tightly with the cap and swirl several times until the tablet is dissolved.
9. Place the vial in the sample chamber making sure that the Σ marks are aligned.
10. Press **TEST** key.

Zero accepted
press ZERO
press TEST

The result is shown in the display in mg/l Zinc.

1.1 Methods

Notes:

1. The tablets must be added in the correct sequence.
2. In the case of high levels of residual chlorine, perform the analysis with a dechlorinated water sample. To dechlorinate add one DECHLOR tablet to the water sample (point 1). Crush and mix to dissolve the tablet. Then add the COPPER / ZINC LR tablet (point 2) and continue with the test procedure as described above.
3. When using the copper/zinc LR tablets, the Zincon indicator reacts with both the zinc and the copper. Therefore, the specified measuring range may possibly refer to the total concentration of both ions.
4. Concentrations above 1mg/l may lead to results within the measurement range. In this case, it is recommended to carry out a dilution of sample prior to analysis as a plausibility check.
5. The addition of an EDTA tablet during the second step of the analysis ensures that any copper presence does not interfere with the test.
6. Before analysis, strong alkaline or acidic samples should be adjusted to pH 9 (with 1 mol/l hydrochloric acid, 1 mol/l sodium hydroxide).

Reagent / Accessories	Form of reagent/Quantity	Order-No.
COPPER / ZINC LR	Tablet / 100	512620BT
EDTA	Tablet / 100	512390BT
DECHLOR	Tablet / 100	512350BT

1.2 Important notes

1.2.1 Correct use of reagents

The reagents must be added in the correct sequence.

Tablet reagents:

The tablet reagents should be added to the water sample straight from the foil without touching them with the fingers.

Liquid reagents:

Add drops of the same size to the water sample by holding the bottle vertically and squeezing slowly.

After use replace the bottle caps securely noting the colour coding.

Note recommendation for storage (e.g. cool and dry).

Powder Packs:

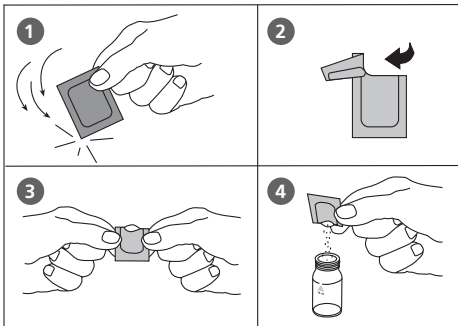

VARIO Chlorine DPD / F10

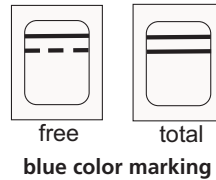

1.2.2 Cleaning of vials and accessories for analysis

Vials, caps and stirring rods should be cleaned thoroughly **after each analysis** to prevent interferences.

Procedure:

Clean vials and accessories after each analysis as soon as possible.

1. Clean vials and accessories with laboratory detergent (e.g. Extran® MA 02 (neutral, phosphatic), Extran® MA 03 (alkaline, phosphate-free) from Merck KGaA).
2. Rinse thoroughly with tap water.
3. On demand (see Notes) perform special cleaning as required, e.g.: rinse with diluted Hydrochloric acid solution.
4. Rinse thoroughly with deionised water.

1.2.3 Guidelines for photometric measurements

1. Vials, caps and stirring rods should be cleaned thoroughly after each analysis to prevent interferences. Even minor reagent residues can cause errors in the test result.
2. The outside of the vial must be clean and dry before starting the analysis. Clean the outside of the vials with a towel. Fingerprints or other marks will be removed.
3. If there is no defined vial for the blank, the zeroing and the test must be carried out with the same vial as there may be slight differences in optical performance between vials.
4. The vials must be positioned in the sample chamber for zeroing and test with the Δ mark on the vial aligned with the ∇ mark on the instrument.
5. Always perform zeroing and test with closed photometer lid.
6. Bubbles on the inside wall of the vial lead to incorrect measurements. To prevent this, remove the bubbles by swirling the vial before performing the test.
7. Avoid spillage of water in the sample chamber. If water should leak into the instrument housing, it can destroy electronic components and cause corrosion.
8. Contamination of the lens in the sample chamber can result in errors. Check at regular intervals and – if necessary – clean the light entry surfaces of the sample chamber using a moist cloth or cotton buds.
9. Large temperature differences between the instrument and the environment can lead to errors – e.g. due to the formation of condensation in the area of the lens or on the vial.
10. To avoid errors caused by stray light do not use the instrument in bright sunlight.

Correct filling of the vial:

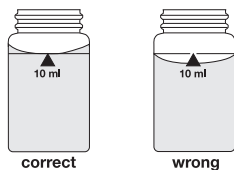

1.2.4 Sample dilution techniques

Proceed as follows for accurate dilutions:

Pipette the water sample (see table) into a 100 ml volumetric flask and fill up to 100 ml mark with deionised water. Swirl to mix the contents.

Water sample [ml]	Multiplication factor
1	100
2	50
5	20
10	10
25	4
50	2

Pipette the required volume of the diluted sample into the vial and proceed as described in the test methods.

Caution:

1. Dilution decreases accuracy.
2. Do not dilute water samples for measurement of pH-values. This will lead to incorrect test results. If "Overrange" is displayed use another instrument (e.g. pH-meter).

1.2.5 Correcting for volume additions

If a larger volume of acid or base is used to pre-adjust the pH-value, a volume correction of the displayed result is necessary.

Example:

For adjusting the pH-value of a 100 ml water sample 5 ml of acid had to be added. The corresponding displayed result is 10 mg/l.

$$\text{Total volume} = 100 \text{ ml} + 5 \text{ ml} = 105 \text{ ml}$$

$$\text{Correction factor} = 105 \text{ ml} / 100 \text{ ml} = 1.05$$

$$\text{Corrected result} = 10 \text{ mg/l} \times 1.05 = 10.5 \text{ mg/l}$$

Part 2

Operating manual

2.1 Operating

2.1.1 Commissioning

Before using the photometer SpectroDirect it is necessary to insert two batteries.

Before using the photometer (PC Spectro II and SpectroDirect) perform the following settings in the Mode-Menu:

- MODE 10: select language
- MODE 12: set date and time
- MODE 34: perform „Delete data“
- MODE 69: perform “User m. init” to initialise the userpolynomial system

(see chapter 2.4 Photometer settings)



2.1.2 Batteries (only SpectroDirect)

Saving data – Important Notes

The batteries save data (stored results and photometer setting) if there is no power from the power supply from the mains adapter. As long as the instrument is energised from the mains adapter the batteries not discharged.

Recommendation: Exchange of the batteries every 3 years.

When no mains adapter supplies energy to the instrument, all stored data and settings will be lost, if the batteries are taken out.

Recommendation: Keep the instrument connected to mains adapter supply while changing the batteries. For replacing the batteries please refer to chapter 3.6.3.4 Changing the batteries (only SpectroDirect).



2.1.3 Lithium-battery (only PC Spectro II)

Saving data – Important Notes

Factory-wise the instrument is delivered with one lithium battery already in place and a second, spare one. For replacing the lithium battery please refer to chapter 3.6.3.3 Changing the lithium battery.

The lithium battery saves data (stored results and photometer setting) if there is no power from the power supply from the mains adapter.

As long as the instrument is energised from the mains adapter the battery not discharged.

Recommendation: Exchange of the lithium battery every 5 years.

When no mains adapter supplies energy to the instrument, all stored data and settings will be lost, if the lithium battery is taken out.

Recommendation: Keep the instrument connected to mains adapter supply while changing the lithium battery.

Attention: Avoid electrostatic discharge as this can destroy the instrument.

2.1.4 Cell chamber and cells

The instrument can be used with the following cells:

Rectangular cells (10 – 50 mm path length):

- 10 mm cells: Insert the cell holder (H) as indicated. Then insert the cell so, that a matt side points towards the viewer.
- 20, 30, 40 mm and other rectangular cells: Insert the cell always in contact to the clip (C) on the left side of the cell chamber.
- 50 mm cells: no cell holder required.

Cylindric cells (16 and 24 mm diameter):





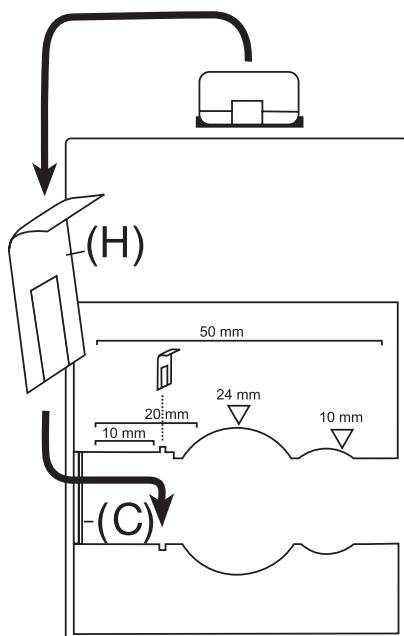







Note: Cylindric cells are called "vials" in the test instructions.

Vials are placed as indicated in the cell holder, the 2 marks matching each other.



2.2 Overview of function keys

2.2.1 Overview

	Switching the photometer on or off
	Returning to selection of methods or previous menu
	Function key: description in the text if key available
	Function key: description in the text if key available
	Function key: description in the text if key available
	Confirming
	Menu of photometer settings and further functions
	Moving the cursor up or down
	Storing of displayed test result
	Performing Zero
	Performing Test
	Displaying date and time / user-countdown

2.2.2 Displaying time and date

 Press [“clock”] key.

19:30:22 2009-06-15

The display shows:

After 15 seconds the photometer reverts to the previous display automatically or press [] key or [ESC].



2.2.3 User countdown

With this function the operator is able to define his own countdown.



Press [“clock”] key.

19.30.20 2009-06-15

The display shows time and date:



Press [“clock”] key.

Countdown
mm : ss
99 : 99

The display shows:

Either press [↵] key to accept the last used user countdown.

or

press any number key to start entering a new value

The entry comprises two digits each.

Enter minutes and seconds,

e.g.: 2 minutes, 0 seconds = [0][2][0][0].

Confirm with [↵] key.



Countdown
02:00
Start: ↵

The display shows:

Start countdown with [↵] key.

After countdown has finished the photometer reverts to the previous display automatically.

2.3 Operation mode

If the photometer is connected with power supply unit to the mains it is ready for use.

Before each start, make sure that the **sample chamber is empty** and the **photometer lid is closed**, as the photometer always performs a selftest when it is switched on.



Switch the photometer on by pressing the ON/OFF key.



The display shows:

Initialisation...



and then:

PC Spectro II

or

SpectroDirect

2.3.1 Selftest

cell chamber empty?

Start: [↶]

The display shows:

**get sure that the cell chamber is empty
and the photometer lid closed**



Start selftest by pressing [↶] key.

selftest...

- now the photometer is performing the selftest for approx. 2 ½ minutes. During this time the following is checked:
- function of the tungsten halogen lamp
- function of the step motor
- accuracy of wavelength with internal Didymium filter and if necessary adjustment (in this case the selftest can be taken up to 5 minutes)
- function of data storage

When selftest is passed the list for method selection is displayed.

2.3.2 Selecting a method

```
>> 30 Alkalinity-m
    35 Alkalinity-p
    40 Aluminium
    .....
```

The display shows a selection:

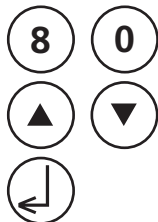

There are two possibilities to select the required method:

- enter method-number directly
e.g.: [8] [0] to select Bromine
- press [▼] or [▲] key to select the required method from the displayed list.

Confirm with [↵] key.

2.3.2.1 Method Information (F1)

Use F1 key to switch between the compact and the detailed list for method selection.

```
100 Chlorine
0.02-6 mg/l Cl2
Tablet
24 mm
DPD No 1
DPD No 3
```

Example:

Line 1: Method number, Method name
Line 2: Range
Line 3: Kind of reagent
Line 4: Vial
Line 5-7: Used reagent
tube = reagent vial contained in tube test

2.3.2.2 Chemical Species Information

Pressing the F2 key the display shows a list with available chemical species and corresponding ranges. Changing chemical species see chapter 2.3.7 page 304.

```
320 Phosphate LR T
0.05-4 mg/l PO4
0.02-1.3 mg/l P
0.04-3 mg/l P2O5
```

Line 1: Method number, Method name
Line 2: Range with chemical species 1
Line 3: Range with chemical species 2
Line 4: Range with chemical species 3

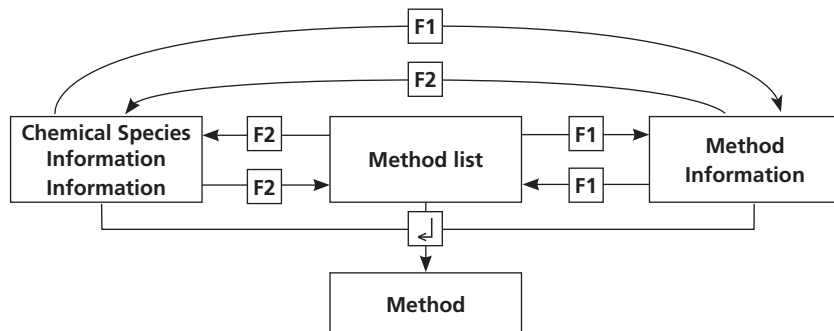

2.3.3 Differentiation

Chlorine
>> diff
free
total

Differentiation is possible in some methods (e.g. Chlorine). The photometer then requires the type of determination.



Press arrow key [▼] or [▲] to select the required determination.



Confirm with [↵] key.

2.3.4 Performing Zero

prepare Zero
press ZERO

The display shows:

Prepare a clean vial as described in “Method” and place the vial in the sample chamber making sure that the Σ marks are aligned.



Press **ZERO** key.

Zero accepted
prepare Test
press TEST

The display shows:

2.3.5 Performing Tests

When zero calibration is complete, remove the vial from the sample chamber and perform the tests as described under "Method".

When the results have been displayed:

- with some methods you can change between different chemical species
- you can store and/or print out the results
- perform further analysis with the same zero
- select a new method

2.3.6 Ensuring reaction periods (countdown)

To ensure compliance with reaction periods a time delay is incorporated: the countdown. There are two kinds of countdowns:

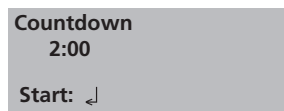

- Press **[↵]** key.
Prepare water sample, start countdown with **[↵]** key and proceed as described in the mode description.
The vial must not be placed in the sample chamber.



- Press **TEST** key.
Prepare the water sample as described in the method description and place the vial in the sample chamber. The display shows the countdown by pressing the **TEST** key and the countdown is started automatically. The reaction period is finished the measurement starts automatically.



Notes:

1. It is possible to finish the working countdown by pressing the **[↵]** key. Reading starts immediately. In this case the operator is responsible for ensuring the necessary reaction period.

Non-compliance with reaction periods leads to incorrect test results.

2. The time remaining is displayed continuously.
The beeper indicates the last 10 seconds.

2.3.7 Changing chemical species

For some methods there is a possibility to change the chemical species of the test result. If the test result is displayed press arrow key [▲] or [▼].

Example:

320 Phosphate LR T	-----[▼]----->	320 Phosphate LR T	<----- [▼] -----	320 Phosphate LR T
0.05-4 mg/l PO ₄		0.02-1.3 mg/l P		0.04-3 mg/l P ₂ O ₅
	<----- [▲] -----		----- [▲] ----->	
1.00 mg/l PO ₄		0.33 mg/l P		0.75 mg/l P ₂ O ₅

If the species of a test result is changed the displayed range is adjusted automatically. For an already stored result it is not possible to change the chemical species. The last displayed chemical species is kept by the instrument and will be displayed if this method is used the next time. If there is the possibility to change the chemical species for a method it is described in the manual. The arrows indicate the possible chemical species and are printed below the notes of the method:

- ▲ PO₄
- P
- ▼ P₂O₅

2.3.8 Storing results



Press **STORE** key while the test result is displayed.

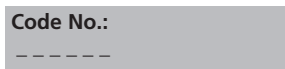

The display shows:



- We advise you to enter a numeric code (up to 6 places). (A Code No. can contain references to the operator or the sampling location.)



After entering confirm with [↙] key.

- If a code number is not necessary confirm by pressing [↙] directly. (The assignment for the Code No. is then 0 automatically.)

The entire data set is stored with date, time, Code No., method and test result.



The display shows:

The test result is then shown again.

**Storage: 900
free records left**

**Storage: only 29
free records left**

Note:

The display shows the number of free data sets.

If there are less than 30 data sets free the display shows:

Clear the memory as soon as possible (see "Deleting stored results"). If memory capacity is used up it is impossible to save additional test results.

2.3.9 Printing results

If a printer is installed and switched on, it is possible to print out the test results (without saving it beforehand).



Press **F3** key.

The entire data set is printed with date, time, Code No., method and test result. Printing example:

```
100 Chlorine T
0.02-6 mg/l Cl2
Profi-Mode: no
2009-07-01 14:53:09
Test No.: 1
Code No.: 007
4.80 mg/l Cl2
```

The test No. is an internal number that is set automatically if a test result is stored. It appears only on the print out.

2.3.10 Perform additional measurements



To perform additional tests using the same method:

Zero accepted
prepare Test
press TEST

- Press **TEST** key

The display shows:



Confirm with **TEST** key

or



- Press **ZERO** key to perform a new zero calibration.

prepare Zero
press ZERO

The display shows:

2.3.11 Selecting a new method



Press **ESC** key to return to method selection.



Or enter the required method number directly,
e.g. [1] [6] [0] for CyA-TEST (Cyanuric acid).



Confirm with [↵] key.

2.4 Photometer settings: Table of MODE Functions

MODE-Function	No.	Description	Page
Abs / Trans	51	Measurement of Extinction and Transmission at selected wavelength	327
Calibration	40	Fluoride calibration	321
Clear calibration	46	Deleting user calibration	325
Clock	12	Setting date and time	309
Countdown	13	Switching the countdown on/off to ensure reaction times	310
Delete data	34	Deleting all stored results	321
Key beep	11	Switching the acoustic signal on/off to indicate key-pressing	309
Kinetics	54	Time dependent description of a reaction	330
Langelier	70	Calculation of Langelier saturation Index (Water Balance)	192
Language	10	Selecting language	308
LCD contrast	80	Setting the display contrast	346
LCD brightness	81	Setting the display brightness	346
Method list	60	User method list, adaption	334
M list all on	61	User method list, switching on all methods	335
M list all off	62	User method list, switching off all methods	335
Print	20	Printing all stored results	312
Print, code no.	22	Print only results of a selected Code No. range	314
Print, date	21	Print only results of a selected time period	313
Print, method	23	Print only results of one selected method	315
Printing parameters	29	Setting of printing options	316
Profi-Mode	50	Switching the detailed operator instructions on/off	326
Signal beep	14	Switching the acoustic signal on/off to indicate end of reading	311
Spectrum (Scan)	53	Absorption scanning about a max. range between 330 and 900 nm	328
Storage	30	Displaying all stored results	317
Stor., code	32	Displaying only results of a selected Code No. range	319
Stor., date	31	Displaying only results of a selected time period	318

MODE-Function	No.	Description	Page
Stor., method	33	Displaying only results of one selected method	320
System info	91	Information about the instrument e.g. current software version	347
Temperature	71	Selection of °C or °F for Langelier Mode 70	345
User calibration	45	Storage of user calibration	324
User concentration	64	Entering the data necessary to run a user concentration method	336
User polynoms	65	Entering the data necessary to run a user polynomial	338
User methods clear	66	Delete all data of a user polynomial or of a concentration method	341
User methods print	67	Print out all data stored with mode 64 (concentration) or mode 65 (polynomial)	342
User methods init	69	Initialise the user method system (polynomial and concentration)	343

The selected settings are kept by the photometer even when switched off. To change photometer settings a new setting is required.

2.4.1 blank because of technical requirements

2.4.2 Instrument basic settings 1

Selecting a language



Press [MODE] [1] [0] keys.



Confirm with [↵] key.

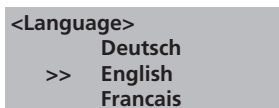

The display shows:

Press arrow key [▼] or [▲] to select the required language from the displayed list.



Confirm with [↵] key.

Key beep



Press [MODE] [1] [1] keys.



Confirm with [↵] key.

<Key Beep>
ON: 1 OFF: 0

The display shows:



- Press [0] key to switch the key beep off.



- Press [1] key to switch the key beep on.



Confirm with [↵] key.

Note:

In the case of methods with reaction periods, an acoustic signal still sounds during the last 10 seconds of the countdown even if the key beep is switched off.

Setting date and time



Press [MODE] [1] [2] keys.



Confirm with [↵] key.

<clock>
yy-mm-dd hh:mm
--:-- -:--

The display shows:

The entry comprises two digits each.

yy-mm-dd hh:mm
09-05-14 -:--

Enter year, month and day,
e.g.: 14. May 2009 = [0][9][0][5][1][4]

yy-mm-dd hh:mm
09-05-14 15:07

Enter hours and minutes
e.g.: 3.07 p.m. = [1][5][0][7]



Confirm with [↵] key.

Note:

While confirming date and time with [↵] key the seconds are adjusted to zero automatically.

Countdown (Ensuring reaction periods)

Some methods require a reaction period. This reaction period is incorporated in the method as standard with the countdown function.

It is possible to switch the countdown off for all methods:



Press [MODE] [1] [3] keys.



Confirm with [↵] key.

<Countdown>
ON: 1 OFF: 0

The display shows:



- Press [0] key to switch the countdown off.



- Press [1] key to switch the countdown on.



Confirm with [↵] key.

Notes:

1. It is possible to interrupt the working countdown by pressing the [↵] key (application e.g. serial analysis).
The "user countdown" is also available if the countdown is switched off.
2. If the countdown function is switched off, the operator is responsible for ensuring the necessary reaction period. **Non-compliance with reaction periods leads to incorrect test results.**

Signal beep

Performing a zero or a measurement takes 8 seconds. The photometer indicates the end of zeroing or measuring by a short beep.



Press [MODE] [1] [4] keys.



Confirm with  key.

<Signal Beep>
ON: 1 OFF: 0

The display shows:



- Press [0] key to switch the signal beep off.



- Press [1] key to switch the signal beep on.



Confirm with  key.

Note:

In the case of methods with reaction periods, an acoustic signal still sounds during the last 10 seconds of the countdown even if the key beep is switched off.

2.4.3 Printing of stored results

Printing all results



Press [MODE] [2] [0] keys.



Confirm with [↵] key.

```
<Printing>
Print all Data
Start:  ↵
cancel: ESC
```

The display shows:



Press [↵] key for printing out all stored test results.

```
Test No.:
```

The display shows e.g.:

After printing the photometer goes back to mode menu automatically.

Note:

It is possible to cancel the entry by [ESC].
All stored data are printed out.

Printing results of a selected time period



Press [MODE] [2] [1] keys.



Confirm with [↵] key.

<Print>
sorted: date
from yy-mm-dd
- - -

The display shows:

Enter year, month and day for the first day of the required period, e.g.: 14 May 2009 = [0][9][0][5][1][4]



Confirm with [↵] key.

to yy-mm-dd
- - -

The display shows:

Enter year, month and day for the last day of the required period, e.g.: 19 May 2009 = [0][9][0][5][1][9]



Confirm with [↵] key.

from 2009-05-14
to 2009-05-19
Start: ↵
cancel: ESC

The display shows:

Press [↵] key and all stored results in the selected date range are printed.

After printing the photometer goes back to mode menu automatically.

Note:

It is possible to cancel the entry by [ESC].

If you want to print only results of one day enter the same date twice to determine the period.

Printing results of a selected Code No. range



Press [MODE] [2] [2] keys.



Confirm with [↵] key.

```
<Print>
sorted: Code No.
from -----
```

The display shows:

Enter numeric code number (up to 6 places) for the first required Code No., e.g.: [1].



Confirm with [↵] key.

```
to -----
```

The display shows:

Enter numeric code number (up to 6 places) for the last required Code No., e.g.: [1] [0].



Confirm with [↵] key.

```
from 000001
to 000010
Start: ↵
cancel: ESC
```

The display shows:

Press [↵] key and all stored results in the selected code number range are printed.

After printing the photometer goes back to mode menu automatically.

Note:

It is possible to cancel the entry by [ESC].

If you want to print only results of one code number enter the same code number twice.

If you want to print all results without code no. (code no. is 0) enter Zero [0] twice.

Printing results of one selected method



Press [MODE] [2] [3] keys.



Confirm with [↵] key.

```
<Print>
>>20 Acid demand
  30 Alkalinity-total
  40 Aluminium T
```

The display shows:

Select the required method from the displayed list or enter the method number directly.



Confirm with [↵] key.

In case of differentiated methods select the required kind of determination and confirm with [↵] key.

```
<Print>
method
30 Alkalinity-total
Start:  ↵
cancel: ESC
```

The display shows:

Press [↵] key and all stored results of the selected method are printed.

After printing the photometer goes back to mode menu automatically.

Printing Parameter



Press [MODE] [2] [9] keys.



Confirm with [↵] key.

<printing parameter>

1: Flow control

2: Baud rate

cancel: ESC

The display shows:



Press [1] key to select "Flow control".

<Flow Control>

is: Hardware

select: [▲] [▼]

save: ↵

cancel: ESC

The display shows:



Press arrow key [▼] or [▲] to select the required Protocol.
(Xon/Xoff, Hardware, no control)



Confirm with [↵] key.



Finish with **ESC** key.
Flow Control will be set to the selection displayed at "is".



Press [2] key to select "Baud rate".

<Baud rate>

is: 19200

select: [▲] [▼]

save: ↵

cancel: ESC

The display shows:



Press arrow key [▼] or [▲] to select the required baud rate.
(600, 1200, 2400, 4800, 9600, 14400, 19200)



Confirm with [↵] key.



End with **ESC** key.

Back to mode menu with **ESC** key.

Back to method selection with **ESC** key.

Note:

Select "Hardware" as Flow control and "19200" as baud rate if you use the printer **DP 1012**.

Select "Hardware" as Flow control and "9600" as baud rate if you use the printer **DPN 2335**.

For setting of the printer see chapter 2.5.1 Connection to a printer.

2.4.4 Recall / delete stored results

Recall all stored results



Press [MODE] [3] [0] keys.



Confirm with [↵] key.

```
<Storage>
display all data
Start: ↵ cancel: ESC
print: F3
print all: F2
```

The display shows:

The stored data sets are displayed in chronological order, starting with the latest stored test result. Press [↵] key and all stored results are displayed.

- Press [F3] key to print the displayed result.
- Press [F2] key to print all results.
- End with [ESC].
- Press arrow key [▼] to display the following test result.
- Press arrow key [▲] to display the previous test result.



```
no data
```

If there are no test results in memory the display shows:

Recall results of a selected time period



Press [MODE] [3] [1] keys.



Confirm with [↵] key.

<Storage>
sorted: date
from yy-mm-dd
_ _ - _ - _

The display shows:

Enter year, month and day for the first day of the required period, e.g.: 14 May 2009 = [0][9][0][5][1][4].



Confirm with [↵] key.

to yy-mm-dd
_ _ - _ - _

The display shows:

Enter year, month and day for the last day of the required period, e.g.: 19 May 2009 = [0][9][0][5][1][9].



Confirm with [↵] key.

from 2009-05-14
to 2009-05-19
Start: ↵ cancel: ESC
print: F3
print all: F2

The display shows:

- Press [↵] key and all stored results in the selected date range are displayed.
- Press [F3] key to print the displayed result.
- Press [F2] key to print all selected results.
- End with [ESC].

Note:

It is possible to cancel the entry by [ESC].

If you want to recall only results of one day enter the same date twice to determine the time period.

Recall results of a selected Code No. range



Press [MODE] [3] [2] keys.



Confirm with [↵] key.

```
<Storage>
sorted: Code-No.
from _____
```

The display shows:

Enter numeric code number (up to 6 places) for the first required Code No., e.g.: [1].



Confirm with [↵] key.

```
to _____
```

The display shows:

Enter numeric code number (up to 6 places) for the last required Code No., e.g.: [1] [0].



Confirm with [↵] key.

```
from 000001
to 000010
Start: ↵ cancel: ESC
print: F3
print all: F2
```

The display shows:

- Press [↵] key and all stored results in the selected Code No. range are displayed.
- Press [F3] key to print the displayed result.
- Press [F2] key to print all selected results.
- End with [ESC].

Note:

It is possible to cancel the entry by [ESC].

If you want to recall only results of one code number enter the same code number twice.

If you want to recall all results without code no. (code no. is 0) enter Zero [0] twice.

Recall results of one selected method



Press [MODE] [3] [3] keys.



Confirm with [↵] key.

```
<Storage>
>>20 Acid demand
  30 Alkalinity-total
  40 Aluminium T
```

The display shows:

Select the required method from the displayed list or enter the method number directly.



Confirm with [↵] key.

In case of differentiated methods select the required kind of determination and confirm with [↵] key.

```
<Storage>
method
30 Alkalinity-total
Start: ↵ cancel: ESC
print: F3
print all: F2
```

The display shows:

- Press [↵] key and all stored results of the selected method are displayed.
- Press [F3] key to print the displayed result.
- Press [F2] key to print all selected results.
- End with [ESC].

Delete stored results



Press [MODE] [3] [4] keys.



Confirm with [↵] key.

<Delete data>
Delete all data?
YES : 1 NO : 0

The display shows:



- Press [0] key to retain the data sets in memory.



- After pressing key [1] the following acknowledgment is displayed:

<Delete data>
Delete data ↓
Do not delete: ESC

Press [↵] key to delete.

ATTENTION:
All stored test results are deleted

or cancel without deleting data by pressing [ESC] key.

Note:

All stored test results are deleted.

2.4.5 Calibration

Fluoride Calibration



Caution: See notes!

Press [MODE] [4] [0] keys.



Confirm with [↵] key.

<Calibration>
170 Fluoride
Zero: deionised water
press ZERO

The display shows:

1. Fill a clean vial (24 mm Ø) with exact **10 ml of deionised water**, close tightly with the cap.
2. Place the vial in the sample chamber making sure that the marks \times are aligned.

3. Press **ZERO** key.
4. Remove the vial from the sample chamber.
5. Add **exactly 2 ml SPADNS reagent solution** to the water sample. **Caution: Vial is filled up to the top!**
6. Close the vial tightly with the cap and swirl gently several times to mix the contents.
7. Place the vial in the sample chamber making sure that the Σ marks are aligned.
8. Press **TEST** key.
9. Remove the vial from the sample chamber, empty the vial, rinse vial and cap several times and then fill the vial with exact **10 ml Fluoride standard** (Concentration 1 mg/l F).
10. Add **exactly 2 ml SPADNS reagent solution** to the Fluoride standard.
Caution: Vial is filled up to the top!
11. Place the vial in the sample chamber making sure that the Σ marks are aligned.

Zero accepted
T1: 0 mg/l F
press TEST

T1 accepted
T2: 1 mg/l F
press TEST

Calibration
accepted



12. Press **TEST** key.

The display shows:

Confirm with **[↵]** key.

Back to method selection with **ESC** key.

Select Fluoride method with keys [1][7][0] and **[↵]**.

Note:

The same batch of SPADNS reagent solution must be used for adjustment and test. The adjustment process needs to be performed for each new batch of SPADNS reagent solution (see Standard methods 20th, 1998, APHA, AWWA, WEF 4500 F D., S. 4-82).

As the test result is highly dependent on exact sample and reagent volumes, the sample and reagent volumes should always be metered by using a 10 ml resp. 2 ml volumetric pipette (class A).

If an error message appears please repeat adjustment.

Error, absorbance
T2>T1



User Calibration

If a test method is user calibrated the method name is displayed inverse.

Procedure:

- Prepare a standard of known concentration and use this standard instead of the sample according to the test procedure.
- It is recommend to use well known standards which are formulated according to DIN EN, ASTM or other international norms or to use certified standards which are commercially available.
- After measuring this standard solution it is possible to change the displayed results to the required value.
- If a method uses a mathematic equation for the calculation of the result, it is only possible to calibrate the basic tests since all the other tests use the same polynomial.
- The same applies for some test procedures which use a polynomial from another test procedure.

Please find information about useful calibration points at our homepage in the download area.

Return to factory calibration:

If the user calibration is deleted the factory calibration is automatically activated.

Remarks:

The "Fluoride" method cannot be calibrated with mode 45 since the test requires a calibration related to the batch of the liquid reagent (SPADNS) (mode 40, chapter calibration (fluoride)).

Store user calibration

100 Chlorine T
0.02-6 mg/l Cl₂
0.90 mg/l free Cl₂

Perform the required method as described in the manual using a standard of known concentration instead of the water sample.



If the test result is displayed press [MODE] [4] [5] keys and confirm with [↵] key.



The display shows:

<user calibration>
100 Chlorine T
0.02-6 mg/l Cl₂
0.90 mg/l free Cl₂
up: ↑, down: ↓
save: ↵

Pressing the arrow key [▲] once increases the displayed result.

Pressing the arrow key [▼] once decreases the displayed result.

Press keys till the displayed result corresponds to the value of the standard.



Confirm with [↵] key to store the new calibration factor.

Cancel user calibration by pressing [ESC] key.

Jus Factor
saved

The display shows:

100 Chlorine T
0.02-6 mg/l Cl₂
1.00 mg/l free Cl₂

Now the method name is displayed inverse and the test result is calculated with the new calibration factor.

Delete user calibration

This chapter only applies for methods which can be user calibrated.

**100 Chlorine T
0.02-6 mg/l Cl2**

Select the required method.

**prepare ZERO
press ZERO**

Instead of zeroing the instrument press [MODE] [4] [6] keys and confirm with [↵] key.

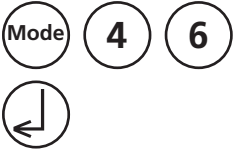

**<user calibration>
100 Chlorine T
0.02-6 mg/l Cl2
clear user
calibration?
YES: 1, NO: 0**

The display shows:

1

Press [1] key to delete user calibration.

0

Press [0] key to keep the valid user calibration.

The instrument goes back to Zero-query automatically.

2.4.6 Lab function

Reduced operator guidance => "Profi-Mode"

This function may be used for routine analyses with many samples of one method. The following information is always stored in the methods:

- a) Method
- b) Range
- c) Date and time
- d) Differentiation of results
- e) Detailed operator instruction
- f) Compliance with reaction periods

If the Profi-Mode is active, the photometer provides only a minimum of operator instructions. The criteria specified above in d, e, f are no longer included.



Press [MODE] [5] [0] keys in succession.



Confirm with [↵] key.

<Profi-Mode>
ON : 1 OFF : 0

The display shows:



- Press [0] key to switch the Profi-Mode off.



- Press [1] key to switch the Profi-Mode on.

switched off

The display shows:

or

switched on



Confirm with [↵] key.

Note:

Storage of test results is possible. When results are stored the display also shows "Profi-Mode".

The selected settings are kept by the photometer even when it is switched off. To change photometer setting a new setting is required.

Absorption / Transmission



Press [MODE] [5] [1] keys.



Confirm with [↵] key.

< Abs / Trans >
wavelength: ____ nm

The display shows:



Select wavelength between 330 and 900 nm e.g.: [5] [4] [0] and confirm with [↵] key.



wavelength set

The display shows:

wavelength: 540 nm
prepare Zero
press ZERO

and then:

Place the blank* into the sample chamber.
(* e.g. cell with deionised water or reagent blank, ...)



Press **ZERO** key.

Zero accepted
prepare Test
press TEST

Place the cell with the test solution into the sample chamber.



Press **TEST** key.

< Abs / Trans >
wavelength: 540 nm
E: 0.596
T: 25, 3 %

The result is shown in the display as **Extinction** (in Abs) and **Transmission** (in %).

Spectrum (Scan)

A wavelength scan can be performed in the range of 330 to 900 nm.
The minimum range between start and stop wavelength is 10 nm.



Press [MODE] [5] [3] keys.



Confirm with [↵] key.

< Spectrum >
Start: ___ nm

The display shows:



Enter start wavelength:
e.g.: [4] [0] [0] and confirm with [↵] key.

< Spectrum >
End: ___ nm



Enter end wavelength:
e.g.: [6] [2] [1] and confirm with [↵] key.

< Spectrum >
400 – 621 nm
prepare Zero
press ZERO

The display shows:

Place a filled cell (the blank) into the sample chamber (Note 1).



Press **ZERO** to start null balance (the baseline).

Zero accepted
prepare Test
press TEST

The display shows:

Place the cell with the test solution into the sample chamber.



Press **TEST** key.

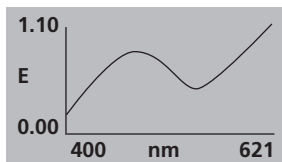

The display shows the graphic of the measured spectrum.



Press F1 key to switch between the graphic and the results (peaks & valleys).

P: 460 nm 1.000 E
V: 555 nm 0.951 E

Now the display shows the calculated peaks (P) and valleys (V).



Use arrow keys [▲] oder [▼] to scroll in the result list.



When in graphic display the F3 key will print the result list (nm / mAbs) or transfer the data to a PC (using HyperTerminal).

When in peak & valley list the F3 key will print the peak & valley data.



Press ESC key to get back to wavelength selection.
 Press ESC again to get back to mode menu.

Notes:

1. It is possible to perform the baseline against air. For the measurement of water samples it is recommend to use a cell filled with deionised water.
2. 1000 mAbs = 1.000 E (or Abs)
 1 mAbs = 0.001 E (or Abs)

Kinetic

With method 54 Kinetic it is possible to describe the time dependency of a reaction (e.g. time of colour development). The maximum number of measuring points is 199 with an interval time of 6 to 999 seconds. Concentrations of unknown samples can be calculated by a known factor. The factor calculation is placed right before the sample measurement. To evaluate the factor the slope of a best fit straight line through the measured Absorbance values is used. For future measurements the factor can be entered by an option. If the sample concentration is not of interest the factor shall be entered with one.

Attention: If many points in short time intervals are measured a heating of the vial is possible!

Performance of measurement:



Press [MODE] [5] [4] keys.



Confirm with [↵] key.

< Kinetic >
wavelength:
___ nm

The display shows:



Enter the required wavelength in the range from 330 to 900 nm, e.g. [4][0][0]. Confirm with [↵] key.



Afterwards the following queries are displayed:

< Kinetic >
Time delay:
___ s

Enter the time delay in the range from 0 to 999 sec., e.g. [6] [0]. Confirm with [↵] key.



Interval time:
___ s

Enter the interval time in the range from 6 to 999 sec., e.g. [2] [0]. Confirm with [↵] key.



Number of intervals:

① ⑤



Enter the number of intervals in the range from 2 to 199 sec., e.g. [1] [5]. Confirm with **[↵]** key.

Note:

The complete time of measurement can be calculated as product of the number of intervals with the interval time plus time delay. In the example above the measurement starts 1 minute after pressing [Test] key and has a length of 5 minutes (15 points in a distance of 20 seconds). During the measurement the delay is not considered.

The display shows:

< Kinetic >
1. Factor
2. Standard

- After pressing [1] key a factor can be entered.
- After pressing [2] key a standard of known concentration can be measured.

Factor:

+ _____

⑨ ① ③ ④

**Option: Factor**

Enter a known factor with max. 6 digits after decimal point in scientific notation (Note 2).

- Press **[▲]** or **[▼]** key to change between plus- and minus-sign.
- Enter the factor value with decimal point, e.g. [9][.][3][4].

Confirm with **[↵]** key.

Faktor:

+ 9.34 E + __

▼ ①



Enter the factors exponent.

- Press **[▲]** or **[▼]** key to change between plus- and minus-sign.
- Enter the exponent value, e.g. - 1

Confirm with **[↵]** key.

After confirmation the sample measurement starts automatically (see 'Flow of Standard/Sample Measurement').

Standard: _____

② . ⑤



Option: Standard

Enter the concentration of the standard with max. 3 digits after decimal point, e.g. [2] [.] [5].

Confirm with [↵] key.

After confirmation the standard measurement starts automatically (see 'Flow of Standard/Sample Measurement').

The initialised flow will be passed one time before sample measurement. The calculated factor is used automatically to evaluate the sample concentration. The information of the standard measurement will be displayed and can be transmitted to a computer or printer.

The following sample measurement can be started by pressing [Test] key.

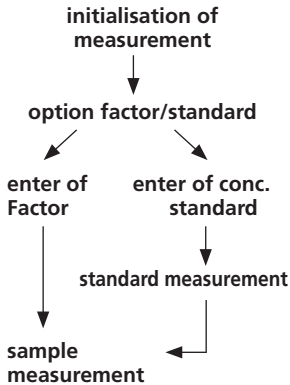

Flow of Standard/Sample Measurement (Note 4)

prepare Zero
press ZERO

Zero

The display shows:*

Place a zero vial in the sample chamber.

Press [Zero] key.

Zero accepted
prepare Test
press TEST

Test

The display shows:

Place a prepared sample vial into the sample chamber.

Press [Test] key.

*Note:

If a standard measurement has been performed before the sample measurement the following lines are displayed:

Zero accepted
prepare Test
press TEST

If the same zero shall be used press [Test] key.

To measure a new Zero press [Zero] key.

Time delay: 28 s

The remaining time delay is displayed as countdown.

After expiration the first measurement takes place.

Measurement: i / n
 Result: y
 Interval time: x s
 t: a / g
 [ESC]

The display shows:

- number of the last measurement (i) / total number of measurements (n)
- the result of the last measurement (y), (Note 1)
- the remaining interval time to the next measurement (x)
- the already expired time (a) / total measuring time (g)

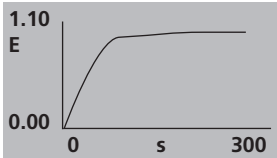

Note:

The test series can always be interrupted by pressing [Esc] key. The already measured values remain maintained.

After the last measurement the time dependency chart of the absorbance is displayed.



Press [F1] key to switch between chart and value table.

Factor: _____
 Slope: _____
 Konz.: _____

T ₀	0 s	_____	Abs
T ₁	x ₁ s	_____	Abs
"	"	"	"
"	"	"	"
"	"	"	"
T _n	x _n s	_____	Abs

The value table shows:

- the used factor to calculate the sample concentration.
- the evaluated slope of the displayed chart.
- the calculated concentration due to the used factor.
- the measured absorbances in Abs at the time points T after x seconds



To scroll through the values use the arrow keys [▲] or [▼].



The value table can be printed or transmitted to a PC (use of Hyperterminal) by pressing [F3] key.



Press [Esc] key to initialise a new measurement.

To start a new sample measurement press [Test] key.

Notes:

1. By pressing [F1] key the displayed measurement result can be switched from Absorbance to %-Transmission.
2. The factor has to be entered in scientific notation with max. 6 digits after decimal point, e.g. 121.3673 = 1.213567 E+02.
3. All displayed values are limited to 9.999 E ± 09. This value is an error-indicator, there is no additional error message.
4. If a standard measuring is performed **standard: conc.** will be displayed during the measurement.

2.4.7 User operations

User method list

After switching on the instrument a scroll list of all available methods is automatically shown in the display. To shorten this list according to the requirements of the user it is possible to create a user defined scroll list.

After performing the update successfully new methods are displayed in the user-method list automatically.

The program structure requires that this list must have at least one active (switched on) method. For this reason it is necessary to activate first all required methods and then to switch off the automatically activated one if this method is not required.

User method list, adaptation



Press [MODE] [6] [0] keys.



Confirm with [↵] key.

```
<Method list>
selected: •
toggle: F2
save: ↓
cancel: ESC
```

The display shows:



Start with [↵] key.

```
<Method list>
>> 30•Alkalinity-tot
    40•Aluminium
    50•Ammonia
....
```

The complete method list is displayed.

Methods with a point [•] behind the method number will be displayed in the method selection list. Methods without a point will not be displayed in the method selection list.

```
>> 30•Alkalinity-tot
```

Press key [▲] or [▼] to select the required method from the displayed list.



Switch with [F2] key between "active" [•] and "inactive" [].

```
>> 30 Alkalinity-tot
```



Select next method, activate or inactivate it and continue.

```
>> 30•Alkalinity-tot
```

Confirm with [↵] key.



Cancel without storing by pressing [ESC] key.

Recommendation:

If only a few methods are required it is recommended to perform Mode 62 first, followed by Mode 60.

All user Polynomials (1-25) and Concentrations (1-10) are displayed in the method list, although they are not programmed by the user. Non-programmed user methods can't be activated!

User method list, switch all methods on

This mode function activates all methods. After switching on the instrument a scroll list of all available methods is automatically shown in the display.



Press [MODE] [6] [1] keys.



Confirm with **[↵]** key.

**<Mlist all on>
switch on all
methods
YES: 1, NO: 0**

The display shows:



- Press [1] key to display all methods in the method selection list.



- Press [0] key to keep the valid method selection list.

The instrument goes back to mode menu automatically.

User method list, switch all methods off

The program structure requires that the method list must have at least one active (switched on) method. For this reason the instrument activates one method automatically.



Press [MODE] [6] [2] keys.



Confirm with **[↵]** key.

**<Mlist all off>
switch off all
methods
YES: 1, NO: 0**

The display shows:



- Press [1] key to display only one method in the method selection list.



- Press [0] key to keep the valid method selection list.

The instrument goes back to mode menu automatically.

User Concentration Methods

It is possible to enter and store up to 10 User Concentration Methods. Therefore you need 2 to 14 standards of known concentration and one blank (deionised water or reagent blank value). The Standards should be measured with increasing concentrations and from the brightest to the darkest colouration.

The measuring range for „Underrange“ and „Overrange“ is defined with -3.5 Abs^* and 9.9 Abs^* . After selection of a method the concentration of the lowest and highest used standard is displayed as measuring range. The operation range should be within this range to achieve best results.

Wavelength can be determined with Mode 53 „Spectrum“

* $1000 \text{ mAbs} = 1 \text{ Abs} = E$ (displayed)

Entering a User Concentration:



Press [MODE] [6] [4] keys.



Confirm with [↵] key.

```
< User concentr.>
choose no.: ____
(850-859)
```

Entry Procedure:

The display shows:

8 5 0

Enter a method number in the range from 850 to 859, e.g.: [8] [5] [0]



Confirm with [↵] key.

```
Overwrite conc. meth.?
YES: 1, NO: 0
```

Note:

if the entered number has already been used to save a concentration the display shows the query:

- Press [0] or [ESC] key to go back to method No. query.
- Press [1] key to start entry mode.

```
wavelength: ____ nm
(330-900 nm)
```

5 5 0

Enter the required wavelength in the range from 330 to 900 nm, e.g.: 550 nm.



Confirm with [↵] key.

```
choose unit:
>>
mg/l
g/l
mmol/l
mAbs
µg/l
E
A
%
```

Press [▲] or [▼] keys to select the required unit.



Confirm with [↵] key.

choose resolution

- 1: 1
- 2: 0.1
- 3: 0.01
- 4: 0.001

3

Press the appropriate numerical key to select the required resolution, e.g.: [3] for 0.01.

Note:

Please enter the required resolution according to the instrument pre-sets:

range	max. resolutions
0.000 ...9.999	0.001
10.00 ...99.99	0.01
100.0... 999.9	0.1
1000 ...9999	1

Measurement procedure with standards of known concentration:

< User concentr.>
 prepare Zero
 press ZERO

Zero

The display shows:

Prepare Zero and press [Zero] key.

Note:

Use deionised water or reagent blank value.

< User concentr.>
 Zero accepted
 S1: + _____
 ↓ | ESC | F1

0 . 0 5

The display shows:

Enter the concentration of the first standard; e.g.: 0.05

- One step back with [ESC].
- Press [F1] key to reset numerical input.

↩

Confirm with [↩] key.

< User concentr.>
 S1: 0.05 mg/l
 prepare
 press TEST

Test

The display shows:

Prepare the first standard and press [Test] key.

S1: 0.05 mg/l
 E: 0.012 ↓

The display shows the input value and the measured absorption value. Confirm with [↩] key.

S1 accepted
 S2: + _____
 ↓ | ESC | F1

0 . 1

Enter the concentration of the second standard; e.g.: 0.1

- One step back with [ESC].
- Press [F1] key to reset numerical input.

↩

Confirm with [↩] key.

S2: 0.10 mg/l
prepare
press TEST

S2: 0.10 mg/l
E: 0.15 ↵

S2 accepted
S3: + _____
↵ | ESC | F1 | Store



stored!

Prepare the second standard and press [Test] key.

The display shows the input value and the measured absorption value. Confirm with [↵] key.

Note:

- Perform as described above to measure further standards.
- The minimum of measured standards is 2.
- The maximum of measured standards is 14 (S1 to S14).

If all required standards or the maximum value of 14 standards are measured press [Store] key.

The display shows:

The instrument goes back to the mode menu automatically. Now the concentration is stored in the instrument and can be recalled by entering its method number or selecting it from the displayed method list.

TIP:

Save all your concentration data in a written form because in case of power outage (e.g. changing the battery) all concentration data will be lost and must be entered again. You might want to use Mode 67 to transfer all concentration data to a PC.

User Polynomials

It is possible to enter and store up to 25 User Polynomials. The program allows the user to apply a Polynomial up to the 5th degree:

$$y = A + Bx + Cx^2 + Dx^3 + Ex^4 + Fx^5$$

If only a Polynomial of a lower degree is necessary the other coefficients are specified as zero (0), e.g.: for the 2nd degree is D, E, F = 0.

The values of the coefficients A, B, C, D, E, F must be entered in an academic notation with maximal 6 decimal places, e.g.: 121,35673 = 1,213567E+02

Entering a User Polynomial:



Press [MODE] [6] [5] keys.



Confirm with [↵] key.

<User polynoms>
choose no.: ____
(800-824)

The display shows:



Enter a method number in the range from 800 to 824, e.g.: [8] [0] [0]



Confirm with **[↵]** key.

Overwrite polynomial?
YES: 1, NO: 0

Note:

if the entered number has already been used to save a polynomial the display shows the query:

- Press [0] or [ESC] key to go back to method No. query.
- Press [1] key to start entry mode.

wavelength: _____ nm
(330-900 nm)

Enter the required wavelength in the range from 330 to 900 nm, e.g.: 550 nm.

5 5 0



Confirm with **[↵]** key.

< User polynoms >
 $y = A+Bx+Cx^2+Dx^3+Ex^4+Fx^5$
A: + _____

- Press [▲] or [▼] key to change between plus and minus sign
- Enter data of the coefficient A including decimal point, e.g.: 1.32
- Press [F1] key to reset numerical input.

1 . 3 2



Confirm with **[↵]** key.

A: 1.32 _____ E+ _____

- Press [▲] or [▼] key to change between plus and minus sign
- Enter the exponent of the coefficient A, e.g.: 3

3



Confirm with **[↵]** key.

B: + _____

Successively the instrument queries the data for the other coefficients (B, C, D, E and F).

Note:

If zero [0] is entered for the value of the coefficient, the input of the exponent is omitted automatically.



Confirm every input with **[↵]** key.

measurement range
Min E: + _____
Max E: + _____

Enter measurement ranges from -3.5 to +9.9 Abs.

- Press [▲] or [▼] key to change between plus and minus sign.
- Enter the values in Absorbance (E = extinction) for the upper limit (Max) and the lower limit (Min).



Confirm every input with **[↵]** key.

choose unit:

>>

mg/l
g/l
mmol/l
mAbs
µg/l
E
A
%

Press [▲] or [▼] keys to select the required unit.



Confirm with [↵] key.

choose resolution

1: 1
2: 0.1
3: 0.01
4: 0.001

Press the appropriate numerical key to select the required resolution, e.g.: [3] for 0.01.

Note:

Please enter the required resolution according to the instrument pres-sets:

range	max. resolutions
0.000 ...9.999	0.001
10.00 ...99.99	0.01
100.0... 999.9	0.1
1000 ...9999	1

3

stored!

The display shows:

The instrument goes back to the mode menu automatically.

Now the polynomial is stored in the instrument and can be recalled by entering its method number or selecting it from the displayed method list.

TIP:

Save all your polynomial data in a written form because in case of power outage (e.g. changing the battery) all polynomial data will be lost and must be entered again. You might want to use Mode 67 to transfer all polynomial data to a PC.

Delete User Methods (Polynomial or Concentration)

In principle a valid user method can be overwritten.

An existing user method (Polynomial or Concentration) can be totally deleted as well and is removed out of the method selection list:



Press [MODE] [6] [6] keys.



Confirm with [↵] key.

```
<User m. clear>
choose no.: _____
(800-824), (850-859)
```

The display shows:



Enter the number of the User Method you want to delete (in the range from 800 to 824 or 850 to 859), e.g.: 800



Confirm with [↵] key.

```
M800
delete?
YES: 1, NO: 0
```

The query is displayed:



- Press [1] key to delete the selected User Method.



- Press [0] key to keep the valid User Method.

The instrument goes back to mode menu automatically.

Print Data of User Methods (Polynomials & Concentration)

With this Mode function all data (e.g. wavelength, unit ...) of stored user polynomials and concentration methods can be printed out or transferred with HyperTerminal to a PC.



Press [MODE] [6] [7] keys.



Confirm with [↵] key.

```
<User m. print>  
Start: ↵
```

The display shows:



Press [↵] key to print out the data (e.g. wavelength, unit, ...) of all stored User Methods.

```
M800  
M803  
...
```

The display shows e.g.:

After data transfer the photometer goes back to mode menu automatically.

Initialise User Method System (Polynomials & Concentration)

Power loss will cause incoherent data. The user method system must be initialised with this mode function to set it to a predefined state.

ATTENTION:

All stored user methods (polynomial & concentration) are deleted with initialisation.



Press [MODE] [6] [9] keys.



Confirm with [↵] key.

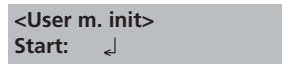

The display shows:



Confirm with [↵] key.

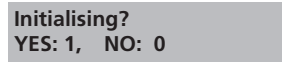

The query is displayed:



- Press [1] key to start initialisation.



- Press [0] key to to cancel without initialisation.

The instrument goes back to mode menu automatically.

2.4.8 Special functions

Langelier Saturation Index (Water Balance)

For calculation the following tests are required:

- pH value
- Temperature
- Calcium hardness
- Total Alkalinity
- TDS (Total Dissolved Solids)

Run each test separately and note the results.

Calculate the Langelier Saturation Index as described:

Calculation of Langelier Saturation Index



With Mode 71 (see below) it is possible to select between degree Celsius or degree Fahrenheit.

Press [MODE] [7] [0] keys.

Confirm with  key.

<Langelier>
temperature °C:
3°C <=T<=53°C
+ _ _ _ _



The display shows:

Enter the temperature value (T) in the range between 3 and 53°C and confirm with  key.
If °F was selected, enter the temperature value in the range between 37 and 128°F.

calcium hardness
50<=CH<=1000
+ _ _ _ _



The display shows:

Enter the value for Calcium hardness (CH) in the range between 50 and 1000 mg/l CaCO₃ and confirm with  key.

tot. alkalinity
5<=TA<=800
+ _ _ _ _



The display shows:

Enter the value for Total Alkalinity (TA) in the range between 5 and 800 mg/l CaCO₃ and confirm with  key.

total dissol. solids
0<=TDS<=6000
+ _ _ _ _



The display shows:

Enter the value for TDS (Total Dissolved Solids) in the range between 0 and 6000 mg/l and confirm with  key.

pH value
0<=pH<=12
+ _ _ _ _



The display shows:

Enter the pH-value in the range between 0 and 12 and confirm with **[↵]** key.

<Langelier>
Langelier
saturation index
0.00
Esc ↵

The display shows the Langelier Saturation Index.

Press **[↵]** key to start new calculation.

Return to mode menu by pressing **[ESC]** key.

Examples:

CH<=1000 mg/l CaCO3!

Values out of defined range:

The entered value is too high.

CH>=50 mg/l CaCO3!

The entered value is too low.



Confirm display message with **[↵]** key and enter a value in the defined range.

Selection of temperature unit

Entering the temperature value is possible in degree Celsius or degree Fahrenheit. Therefore the following preselection is (once) required.



Press **[MODE]** **[7]** **[1]** keys.



Confirm with **[↵]** key.

<temperature>
1: °C 2: °F

The display shows:



Press **[1]** key to select degree Celsius.



Press **[2]** key to select degree Fahrenheit.

The instrument goes back to mode menu automatically.

2.4.9 Instrument basic settings 2

Adjusting display contrast



Press [MODE] [8] [0] keys.



Confirm with [↵] key.

<LCD contrast>
[▲] [▼]

The display shows:



- Press [▲] key to increase contrast of the LCD display.



- Press [▼] key to decrease contrast of the LCD display.



Confirm with [↵] key.

Adjusting display brightness



Press [MODE] [8] [1] keys.



Confirm with [↵] key.

<LCD brightness>

The display shows:

1 ↑ 1 ↓

Press [▲] key to increase brightness of the display about one unit.



Press [▼] key to decrease brightness of the display about one unit.

10 ↑ 10 ↓

Press [Zero] key to increase brightness of the display about ten units.



Press [Test] key to decrease brightness of the display about ten units.

0...254 : 200

The display shows:

The brightness can be selected between 0 and 254 units, e.g.: 200.



Confirm with [↵] key.

2.4.10 Instrument special functions /service

Photometer Information



Press [MODE] [9] [1] keys.



Confirm with [↵] key.

```
<System-Info>
Software:
V012.002.3.003.002
more: ▼, cancel: Esc
```

This method informs you about the current software version, about the current detected mains power supply, about the number of performed tests and free memory capacity.



Press [▼] key to display the number of performed tests and free memory capacity.

```
<System-Info>
Number of Tests:
139
free records left
999
cancel: Esc
```

Finish with [ESC] key.

2.5 Data transfer

Switch the photometer and the personal computer or printer off. Connect the RS232 interface of the photometer (D) and the serial interface of the personal computer or printer using a cable in line with the specified assignment (see technical data). The cable for connection to a personal computer is included in delivery contents.

RS232 interface

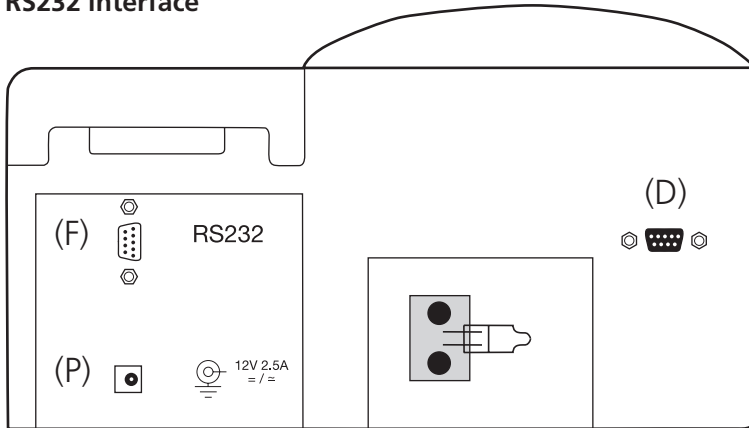

PC Spectro II

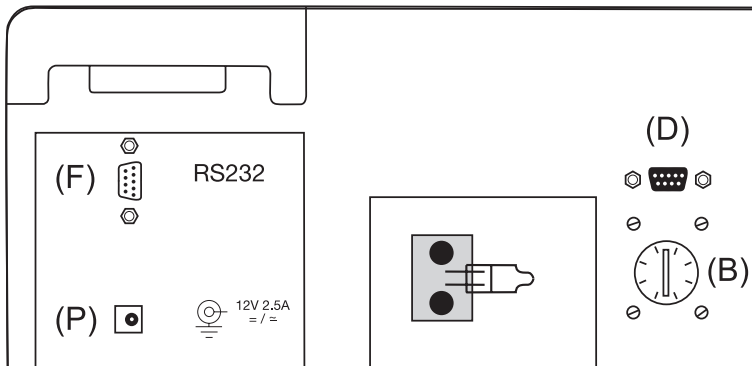

SpectroDirect

There are two RS232 interface at the photometer:

Interface (F) is used factory-wise.

Interface (D) the operator needs to transfer data to a PC or printer or to perform an Update.

2.5.1 Connection to a printer

Printer with a serial connection are suitable for connection with the photometer (see chapter 3.4 Technical data interface).

A suitable paper label printer is the printer DP 1012 or the printer DPN 2335.

Before using the printer **DP 1012** with the Photometer you should change the following standard adjustments:

(Detailed information of changing the adjustment you will find in the printer manual).

Data bits:	8
Parity:	None
Baud rate:	19200
Country:	UK
Print mode:	Text
Auto-off:	5 Min.
Emulation:	Standard
DTR:	Normal

Before using the printer **DPN 2335** with the Photometer you should change the following standard adjustments:

(Detailed information of changing the adjustment you will find in the printer manual).

Baud-rate:	9600
Parity:	None
Data bits:	8

Note: The printer must be connected and switched on before printing.

Caution: Adjust printing parameter in Mode 29. See chapter 2.4.3 Printing Parameter.

2.5.2 Data transfer to a personal computer

Transferring test results from the photometer to a personal computer requires a transfer program, e.g. HyperTerminal.

Please find detailed information at our homepage in the download-area.

2.5.3 Internet Updates

It is possible to update new software applications and additional languages via internet. Please find detailed information at our homepage in the download-area.

The magnet part of the delivery contents is needed for updating the instrument!

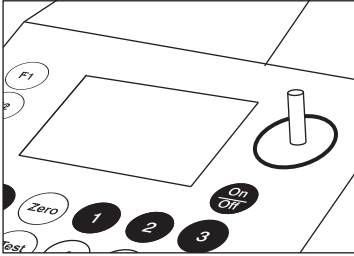

Remark:

To prevent loss of stored test results store or print them out before performing an Update.

Part 3

Enclosure

3.1 Unpacking

Carefully inspect all items to ensure that every part of the list below is present and no visible damage has occurred during shipment. If there is any damage or something is missing, please contact your local distributor immediately.

3.2 Delivery contents



Standard contents for PC Spectro II / SpectroDirect:

- 1 Photometer
- 1 Lithium battery, CR 2032; 3V (only PCSpectro II)
- 2 batteries AA/LR6 (only SpectroDirect)
- 1 Mains adapter, 100 – 240 V, 50 – 60 Hz
- 1 Cable for connection to PC
- 1 Magnet (for updating SpectroDirect)
- 1 Instruction manual
- 1 Manufacturer's Test Certificate M
- 1 Guarantee declaration

**Reagent sets and cells are not part of the standard scope of delivery.
Please see the General Catalogue for details of available reagent sets and cells.**

3.3 blank because of technical requirements

3.4 Technical data

Display	Graphic Display (7-line, 21-characters)
Serial Interface	RS 232 for printer- and PC-connection; 9-pin D-sub-mail connector, data format ASCII, 8-bit data, no parity, 1 start-bit, 1 stop-bit, baud rate and protocol: adjustable Pin assignation: Pin 1 = free Pin 6 = free Pin 2 = Rx Data Pin 7 = RTS Pin 3 = Tx Data Pin 8 = CTS Pin 4 = free Pin 9 = free Pin 5 = GND
Light source	pre-adjusted tungsten halogen lamp (6V, 10W) shelf live: approx. 200 000 measurements
Monochromator	holographic grating (600 lines / mm)
Detector	silicon diode
Wavelength range	330 to 900 nm
Photometric range	-0.3 to 2.5 Abs (Extinction); 0.1–130 % T (Transmission)
Photometric accuracy	0.259 Abs < x < 0.273 Abs at 440 nm 0.250 Abs < x < 0.264 Abs at 635 nm
measured with filters (NIST traceable)	0.548 Abs < x < 0.568 Abs at 440 nm 0.542 Abs < x < 0.562 Abs at 635 nm 0.954 Abs < x < 0.994 Abs at 440 nm 0.907 Abs < x < 0.947 Abs at 635 nm
Drift	± 0.005 Abs/h at 500 nm
Stray light	< 0.5 % at 340 nm und 400 nm
Wavelength accuracy	± 2 nm
Wavelength reproducibility	± 1 nm
Spectral band pass	10 nm
Operation	Acid and solvent resistant touch-sensitive keyboard with integral beeper as acoustic indicator
Power supply	external power supply unit (Input: 100–240V; 50–60Hz; Output: 12 V  30W  Lithium battery CR 2032; 3V (only PC Spectro II); 2 batteries AA/LR6 (only SpectroDirect) for keeping data if there is no power supply from the main adapter
Dimensions (LxWxH)	approx. 265 x 320 x 170 mm (PC Spectro II) approx. 270 x 275 x 150 mm (SpectroDirect)
Weight (unit)	approx. 3 kg (with power supply unit)
Working conditions	5–40 °C at max. 30–90 % relative humidity (without condensation) Specific accuracy of the photometer only applies at 20 to 25 °C
Language options	English, German, French, Spanish, Italian, Portugese; further languages via Internet Update
Storage capacity	approx. 1000 data sets

Subject to technical modification!

To ensure maximum accuracy of test results, always use the reagent systems supplied by the instrument manufacturer.

3.5 Abbreviations

Abbreviation	Definition
°C	degree Celsius (Centigrade)
°F	degree Fahrenheit °F = (°C x 1.8) + 32
°dH	degree German Hardness
°fH	degree French Hardness
°eH	degree English Hardness
°aH	degree American Hardness
Abs	Absorption unit (\triangle Extinction E) 1000 mAbs = 1 Abs \triangle 1 A \triangle 1 E
μ g/l	(= ppb) Microgram per litre
mg/l	(= ppm) Milligram per litre
g/l	(= ppt) Gram per litre
KI	Potassium Iodide
K _{5.4.3}	Acid demand to pH 4.3 – this method is similar to the Total Alkalinity but converted into the unit “mmol/l”, as the German DIN 38409 demand.
TDS	Total Dissolved Solids
LR	Low Range
MR	Medium Range
HR	High Range
C	Reagents from Chemetrics®
L	Liquid reagent
P	Powder (reagent)
PP	Powder Pack
T	Tablet
TT	Tube Test
DEHA	N,N-Diethylhydroxylamine
DPD	Diethyl-p-phenylenediamine
DTNB	Ellmans reagent
PAN	1-(2-Pyridylazo)-2-naphthol
PDMAB	Paradimethylaminobenzaldehyde
PPST	3-(2-Pyridyl)-5,6-bis(4-phenylsulfonic acid)1,2,4-triazine
TBPE	Tetrabromophenolphthalein Ethyl Ester Potassium Salt
TPTZ	2,4,6-Tri-(2-Pyridyl)-1,3,5-triazine

3.6 Troubleshooting

3.6.1 Operating messages in the display / error display

Display	Possible Causes	Elimination
Overrange	reading is exceeding the range water sample is too cloudy too much light on the photo cell	if possible dilute sample or use other measuring range filtrate water sample
Underrange	result is under the detection limit	indicate result with lower x mg/l x = low end of measuring range; if necessary use other analytical method
Storagesystem error use Mode 34	mains power fails or is not connected	insert or change Lithium battery. Delete data with Mode 34.
Jus Overrange E4	The user-calibration is out of the accepted range.	Please check the standard, reaction time and other possible faults. Repeat the user-calibration
Jus Underrange E4		
Overrange E1	The concentration of the standard is too high / too low, so that during user calibration the limit of the range was exceeded.	Perform test with a standard of lower / higher concentration.
Underrange E1		
E40 user calibration not possible	If the display shows Overrange/ Underrange for a test result a user calibration is not possible	Perform the test with a standard of higher/lower concentration.
Zero not accepted	Light absorption is too great or too low	Refer to chapter 2.3.4 Performing Zero (page 272) Clean sample chamber. Repeat zeroing.

Display	Possible Causes	Elimination
<p>???</p> <p>Example 1</p> <p>0.60 mg/l free Cl ??? comb Cl 0.59 mg/l total Cl</p> <p>Example 2</p> <p>Underrange ??? comb Cl 1.59 mg/l total Cl</p> <p>Example 3</p> <p>0.60 mg/l free Cl ??? comb Cl Overrange</p>	<p>The calculation of a value (e.g. combined Chlorine) is not possible</p>	<p>Test procedure correct? If not – repeat test</p> <p>Example 1: The readings for free and total Chlorine are different, but considering the tolerances of each reading they are the same. For this reason the combined Chlorine is most likely zero.</p> <p>Example 2: The reading for free Chlorine is under the detection limit. The instrument is not able to calculate the combined Chlorine. In this case the combined Chlorine is most likely the same as the total Chlorine.</p> <p>Example 3: The reading for total Chlorine is exceeding the range. The instrument is not able to calculate the combined Chlorine. The test should be repeated with a diluted sample.</p>
<p>Error absorbance e.g.: T2>T1</p>	<p>Fluoride calibration was not correct</p>	<p>Repeat calibration</p>
<p>Printer "timeout"</p>	<p>printer switched off; no connection</p>	<p>Connect printer Check connections Switch printer on</p>

3.6.2 General

Finding	Possible Causes	Elimination
Test result deviates from the expected	Chemical species not as required	Press arrow keys to select the required chemical species.
No differentiation: e.g. for the Chlorine test there is no selection between differentiated, free or total.	Profi-Mode is switched on	Switch Profi-Mode off with Mode 50.
The pre-programmed countdown is not displayed.	Countdown is not activated and/or the Profi-Mode is activated.	Switch the countdown on with Mode 13 and/or switch the Profi-Mode off with Mode 50.
It seems that a method is not available.	Method is not activated in the user method list.	Activate the required method in the user method list with Mode 60.

3.6.3 Service / Maintains

3.6.3.1 Handling & Cleaning

- Use the instrument only under ambient environmental conditions (e.g. no extreme heat, dust, humidity).
- For cleaning the instrument just use a damp tissue, no solvents.
Always close the cell chamber lid to protect the optics.
- Avoid spillage of water in the cell chamber. If water should leak into the instrument housing, it can destroy electronic components and cause corrosion.

3.6.3.2 Changing the light source

The light source is a high quality pre-adjusted halogen lamp. Nevertheless from time to time it may be necessary to change this pre-assembled component.

Please follow the instructions:

CAUTION: Disconnect the instrument from mains and remember, if instrument has been used recently the lamp can still be hot.

Note: Don't touch the new halogen lamp (L) with the fingers since this would possibly interfere with a shelf life of the component.

- 1) Disconnect the instrument from mains.
- 2) Take out the metal plate serving as cover of light source.
- 3) Unscrew (S) and take out the old halogen lamp module (M).
- 4) Take the new pre-adjusted halogen lamp module out of the packing and fix it.
- 5) Fix the screws and put the metal plate back into position.
- 6) Connect the instrument to the mains and start selftest.

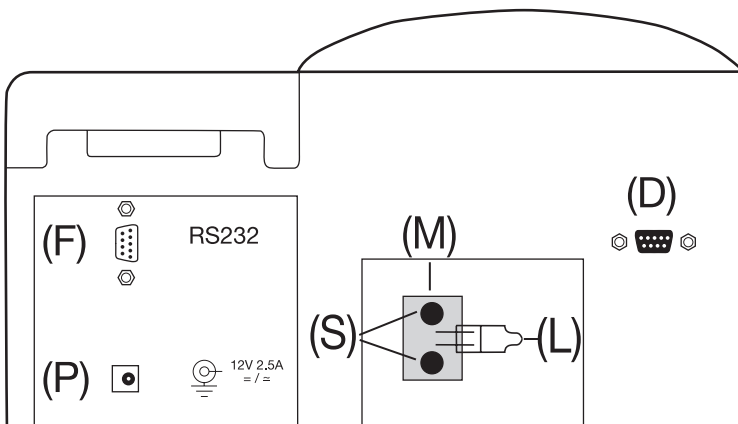

3.6.3.3 Changing the lithium battery (only PC Spectro II)

1. Switch the instrument off.
2. Unscrew the front plate (1).
3. Remove the front plate carefully lifting it up and pushing it backwards (2-4).
Attention: Don't destroy the cable connection.
4. Remove the old lithium battery (5).
5. Place the new lithium battery into the holder with the correct polarity.
6. Put the front plate back into position.
7. Fix the front plate with the screw.

Caution:

Dispose lithium batteries according to the local regulations.

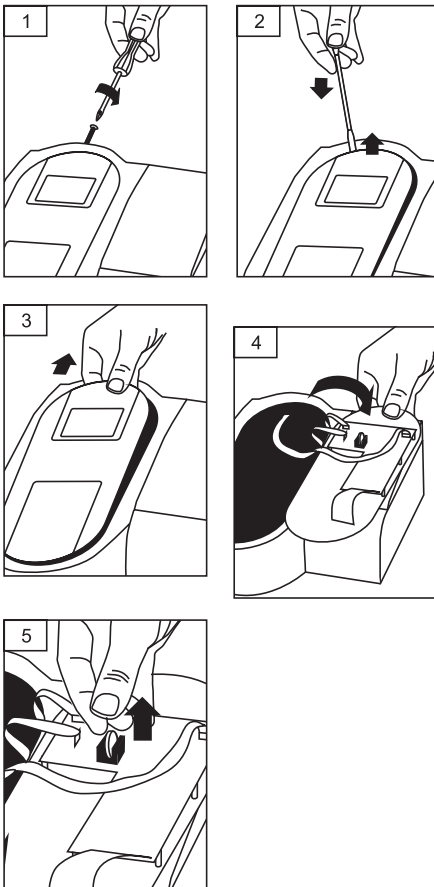

3.6.3.4 Changing the batteries (only SpectroDirect)

1. Switch the instrument off.
2. Open the battery cover (B).
3. Remove the old batteries.
4. Place the new batteries into the holder with the **correct polarity**.
5. Put the cover back into position and seize it.

Caution:

Dispose batteries according to the local regulations.

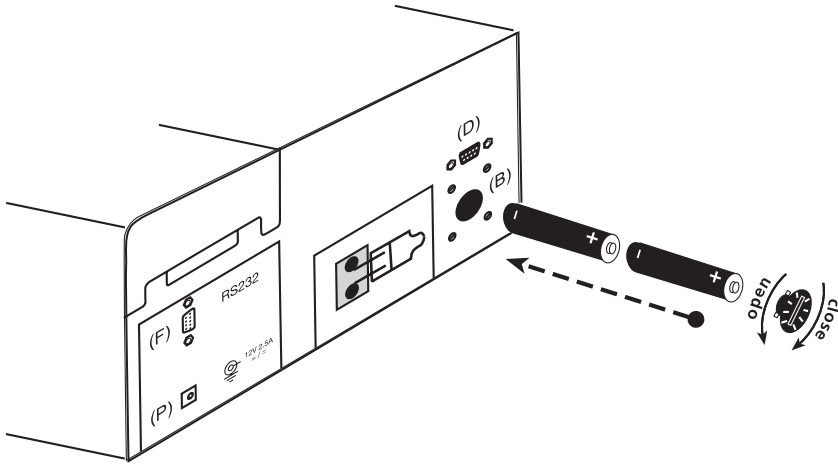

3.7 Declaration of CE-Conformity

Declaration of CE-Conformity

The manufacturer: **Tintometer GmbH**
Schleefstraße 8-12
44287 Dortmund
Deutschland

declares that this product

Product name: **Lovibond® SpectroDirect**

The product above mentioned is in compliance with:

European Union Council Directive of may, 3rd, 1989 regarding the reconciliation of union members legislations relative to Electromagnetic Compatibility (89/336/CEE) (JOCE 23.05.89 L 139/19-26).

Low voltage directive regarding people, animals and goods security during the use of electrical materials which should be employed within certain voltage limits (73/23/CEE).

**This conformity is presumed according to the following standard:
EN 61326 : 1997 + A1 : 1998 + A2 : 2001 + A3 : 2003**

When electrostatic discharge occurs close to the display or the metal parts in the cell chamber, the display or the internal communication may be disturbed. In this case please switch the instrument off, wait a few seconds and restart.

Electromagnetic interference with field strength greater than 3V/m may increase the specified tolerances.

For data transfer and update use the cable delivered with the instrument only.

Dortmund, 26. May 2007



Cay-Peter Voss, Managing Director

Declaration of CE-Conformity

The manufacturer: **Tintometer GmbH**

Schleefstraße 8a
44287 Dortmund
Deutschland

declares that this product

Product name: **Lovibond® PCSPECTRO**

The product above mentioned is in compliance with:

European Union Council Directive of may, 3rd, 1989 regarding the reconciliation of union members legislations relative to Electromagnetic Compatibility (89/336/CEE) (JOCE 23.05.89 L 139/19-26).

Low voltage directive regarding people, animals and goods security during the use of electrical materials which should be employed within certain voltage limits (73/23/CEE).

This conformity is presumed according to the following specifications:

- **EN 50082-1 Standard - 1992 Edition - Immunity Generic Standard**
- **EN 55022 Standard B Class - 1994 Edition - Emission Generic Standard**
- **EN 5081-1 Standard - 1992 Edition - Emission Generic Standard**

Dortmund, 28. May 2001



Cay-Peter Voss, Managing Director

Tintometer GmbH

Lovibond® Water Testing
Schleefstraße 8-12
44287 Dortmund
Tel.: +49 (0)231/94510-0
Fax: +49 (0)231/94510-30
sales@lovibond.com
www.lovibond.com
Germany

The Tintometer Limited

Lovibond House
Sun Rise Way
Amesbury, SP4 7GR
Tel.: +44 (0)1980 664800
Fax: +44 (0)1980 625412
water.sales@lovibond.uk
www.lovibond.com
UK

Tintometer Inc.

6456 Parkland Drive
Sarasota, FL 34243
Tel: 941.756.6410
Fax: 941.727.9654
sales@lovibond.us
www.lovibond.us
USA

Tintometer Spain

Postbox: 24047
08080 Barcelona
Tel.: +34 661 606 770
sales@tintometer.es
www.lovibond.com
Spain

Tintometer China

Room 1001, China Life Tower
16 Chaoyangmenwai Avenue,
Beijing, 100020
Tel.: +86 10 85251111 App. 330
Fax: +86 10 85251001
chinaoffice@tintometer.com
www.lovibond.com/zh
China

Tintometer South East Asia

Unit B-3-12, BBT One Boulevard,
Lebuh Nilam 2, Bandar Bukit Tinggi,
Klang, 41200, Selangor D.E
Tel.: +60 (0)3 3325 2285/6
Fax: +60 (0)3 3325 2287
lovibond.asia@lovibond.com
www.lovibond.com
Malaysia

Tintometer Brazil

Caixa Postal: 271
CEP: 13201-970
Jundiaí – SP
Tel.: +55 (11) 3230-6410
sales@lovibond.us
www.lovibond.com.br
Brazil

Tintometer Indien Pvt. Ltd.

Door No: 7-2-C-14, 2nd, 3rd & 4th Floor
Sanathnagar Industrial Estate,
Hyderabad: 500018, Telangana
Tel: +91 (0) 40 23883300
Toll Free: 1 800 599 3891/ 3892
indiaoffice@lovibond.in
www.lovibondwater.in
India

Technical Changes without notice
Printed in Germany 02/21
Lovibond® and Tintometer®
are registered trademarks of the
Tintometer group of companies.

